



North Fair Oaks Community Council
San Mateo County Coordinated
Departmental Response



Date: September 17, 2014
NFOCC Meeting Date: September 25, 2014
Special Notice / Hearing: None
Vote Required: Majority

To: Members, North Fair Oaks Community Council

From: Michael Schaller, Senior Planner

Subject: Consideration of a zoning text and map amendment to rezone the subject parcels from "PUD-133" to "PUD-137", pursuant to Section 6550 of the County Zoning Regulations for the construction of a 16-unit, two story multi-family supportive housing development at 101/105 5th Avenue in the unincorporated North Fair Oaks area.

RECOMMENDATION:

What is the NFOCC's recommendation to the Planning Commission regarding this requested rezoning of 101/105 5th Avenue to "Planned Unit Development"?

PROPOSAL

The applicant, Mental Health Assoc. of San Mateo County, is proposing to construct a two story multi-family housing development. The building will include 15 studio apartments and a one bedroom managers unit, a community room and on-site laundry rooms. Total proposed floor area of the building will be 13,376 sq. ft. The applicant is proposing 16 uncovered parking spaces for the development.

The proposed rezoning is necessary because the existing zoning of this site allowed a specific 10-unit townhome development with a specific layout and design. Because of the nature of the Planned Unit Development zoning regulations, only that specific design can be built on this property unless the zoning is changed to accommodate a different design and/or use. The current proposal calls for a different number of units (16 versus 10), a different configuration (one building versus two blocks of townhomes), and greater setbacks along the Waverly Avenue frontage (10 feet where 6 feet was previously approved).

BACKGROUND

Applicant/Owner: Mental Health Association of San Mateo County

Location: 101 - 105 5th Avenue, North Fair Oaks

APN(s): 060-265-050, -060, -070

Size: 18,011 sq. ft.

Existing Zoning: PUD – 133 (Planned Unit Development – 133)

General Plan Designation: Commercial Mixed Use, Urban

Sphere-of-Influence: Redwood City

Existing Land Use: Unoccupied storage building and smaller vacant buildings.

Water Supply: California Water Service

Sewage Disposal: Fair Oaks Sewer District

Flood Zone: Flood Zone X (Areas of Minimal Flooding), FEMA Panel No. 06081C0302E, Effective Date: October 16, 2012.

Environmental Evaluation: This project is Statutorily Exempt from the California Environmental Quality Act (CEQA) per Sections 15192 (Threshold Requirements For Exemptions For Agricultural Housing, Affordable Housing, And Residential Infill Projects) and 15194 (Affordable Housing Exemption) of the CEQA Guidelines. An analysis of project compliance with these exemption requirements is included in Attachment B.

Setting: The property is located in a neighborhood commercial district that runs along 5th Avenue and is adjacent to a residential district. It is located at the intersection of 5th Avenue and Waverly Avenue in the unincorporated North Fair Oaks area of San Mateo County. The project site is located within Redwood City's sphere of influence. The property is occupied by existing structures (currently vacant) and paving, with no significant vegetation on-site.

Chronology:

<u>Date</u>	<u>Action</u>
January 23, 2007	- PUD-133 (10-unit townhome development) is approved by the Board of Supervisors. However, this project is never built.
March 5, 2014	- Pre-application public workshop held.

- April 14, 2014 - Application for rezoning received.
- May 1, 2014 - Public meeting hosted by Mental Health Association of San Mateo County
- May 1, 2014 - North Fair Oaks Community Council study session
- September 18, 2014 - 2nd North Fair Oaks Community Council study session
- September 25, 2014 - North Fair Oaks Council meeting

DISCUSSION:

A. KEY ISSUES

1. Compliance with the North Fair Oaks Community Plan

On November 15, 2011, the Board of Supervisors adopted a Community Plan for the North Fair Oaks area (NFOCP). This plan is a subset of the County's General Plan and contains policies for various issues including land use, housing, and circulation, amongst others. It is the policies of the Community Plan that are applicable to this project.

Chapter 2.3 – Land Use Goals and Policies

Goal 2.2: Promote revitalization through redevelopment of underutilized and vacant land in North Fair Oaks to create jobs and housing and support community and economic development.

Policy 2C: Allow residential infill development on vacant and underutilized residential parcels and within areas identified as appropriate for additional mixed use residential, commercial, and other development. Encourage multi-family residential and mixed-use residential development in these areas, and revise subdivision regulations to remove barriers to the development of multi-family attached for-sale housing in all appropriate areas in North Fair Oaks.

Staff's analysis: The project site was formerly used for commercial activities (home construction supplies and materials), but has sat vacant and unused for the last several years. The proposed project would comply with both the goal and the policy by re-utilizing scarce land resources for multi-family residential housing.

Chapter 2.4 - Land Use Designations

The Community Plan has designated the project site as “Commercial Mixed Use”. Within that designation, the plan allows medium to high density land uses, including a mix of multi-family residential, local- and regionally-oriented commercial and institutional uses supported by community facilities. Rezoning to implement the NFOCP is scheduled for 2015; meanwhile the surrounding commercial properties are currently zoned C-1/S-1. The table below summarizes the “Residential” development standards for the Commercial Mixed Use designation against the proposal and, as a point of reference, the S-1 zoning standards (which are currently applicable to the adjacent C-1 zoned lands).

	Residential (NFOCP)	Proposal	S-1 (Surrounding)
FAR	-	68.7%	-
DU/AC (max)	80	38.69	87.0
Building Heights (max)	50 ft. (approx. 5 stories)	25.5 ft. (two stories)	36 (three stories)
Front Setbacks	0 ft. min. 15 ft. max.	10 ft. (front - Waverly)	20 ft.
Side Setbacks	-	10 ft. (5 th Ave.) 5 ft. (non-street)	5 ft.
Rear Setbacks	-	50 ft.	20 ft.
Stepback	at 30 ft. and above	n/a (building is under 30 ft. tall)	-
Parking	1 space/0-1 BR and 1 guest space/5 units	16 spaces	19 spaces required*
* 1 space/studio and 1 guest space/5 units			

Staff's Analysis

The proposed building is well below the maximum allowed density and building height under both S-1 zoning and the NFOCP. The project is in compliance with the NFOCP's front setback requirement, and complies with the S-1 district's side and rear yard setback requirements.

Parking

The project is however, not in compliance with the parking regulations outlined in the NFOCP, nor the existing parking regulations for all development within the County. While the proposal would provide the minimum number of spaces for residential units, the three required guest parking spaces would not be supplied. Additionally, the building will have 362 sq. ft. of office space, which, under the NFOCP, requires one parking space.

However, it is questionable how many of the future residents of this apartment complex will own cars. The applicant's past experience at other facilities they operate would indicate that most of the potential residents are economically disadvantaged and do not possess the resources to purchase or maintain a car. While the applicant has indicated that there will be a number of staff people involved with the day to day functions at the apartment complex, they will not all be there at the same time, nor on every day. The question before the Planning Commission is whether the proposed PUD provides sufficient parking given the circumstances of the project.

What seems more likely is that bicycles will be the primary mode of transportation for some of the residents. The proposed plans do not indicate an area designated for bicycle parking. Staff is recommending a condition of approval (Condition No. 7) which requires the applicant to modify their plans to include bicycle parking on-site. Potential areas where such parking could occur include a portion of the trash enclosure, space within the community room, or converting one of the parking spaces into bicycle parking.

Chapter 4.2 – Infrastructure Goals and Policies

Policy 5C: Continue to require new developments that might result in an increase in stormwater runoff to provide on-site detention facilities to address increased flows. The on-site detention facilities (tank, oversized pipes, or other facilities) shall be sized so that the new development does not cause an increase of flow into the storm drain system.

Staff's analysis: The applicant has not submitted a detailed site drainage plan at this time. Typically such plans are submitted at the building permit stage and a condition of approval (Condition No. 14) has been placed upon the project requiring such plan to be submitted at that time. The project site is large and relatively flat, and there is no reason to believe that the applicant's engineer cannot create a drainage plan (which includes on-site retention) that complies with the County's stormwater permit.

Chapter 6.3 – Housing Goals and Policies

Goal 6.1: Increase affordable housing options in North Fair Oaks.

Policy 1F: In the case of conflicting or unclear regulations or policies, and in the course of discretionary approvals, interpret zoning, land use, and other policies and regulations in a manner that prioritizes creation of new residential uses, particularly affordable and special needs housing, and that discourages reduction of affordable housing stock, including demolition or conversion of residential uses.

Goal 6.8: Provide housing and services for residents experiencing homelessness.

Policy 8A: Encourage the development of transitional and permanent supportive housing in North Fair Oaks.

Staff's analysis: The project will provide affordable housing for a special needs population that currently has few housing options. The project is intended to provide housing for homeless, mentally ill people, a population group that is protected from discrimination by State law. Senate Bill 2 (Chapter 633, Statutes of 2007) revised housing element law to require that transitional and supportive housing be permitted as a residential use, subject only to restrictions that apply to other residential dwellings of the same type in the same zone. The project site is already zoned for residential use (by PUD-133), and the proposed project would continue the use of the site for residential purposes.

Chapter 7.2 – Design of the Private Realm

Section D2 Layout and Orientation – Individual Buildings

Policy D2-1: Orient buildings such that the primary façades (or sides of the building) and key pedestrian entries of the buildings face the street, or face mid-block greenways and mews. Require building entrances on streets, pedestrian ways, and other public spaces rather than, or in addition to, on interior courtyards or parking lots.

Policy D2-2: Encourage corner buildings to actively address both streets with pedestrian-friendly entries.

Staff's analysis: The proposed building's primary entrance (Lobby) is at the Waverly/5th Avenue corner of the parcel and is framed by a cupola tower which will have a slightly taller roof elevation than the rest of the building. This architectural treatment will emphasize that this is the public entrance into the building, and is consistent with these two design policies.

Policy D2-5: Encourage parking and access to parking in the side and rear of lots, to minimize street parking and related disruption to the pedestrian environment. If front parking is essential to a project, provide pedestrian friendly landscaping, design treatments, and amenities such as paths or other improvements to mitigate impacts on the pedestrian environment and overall streetscape.

Staff's analysis: The parking lot for the building will be in the rear portion of the site (Waverly Avenue would be considered the front of the parcel in line with long-standing County policies regarding lot orientation). Access to the

parking area is off of 5th Avenue, approximately 110 ft. away from the intersection of Waverly/5th Avenue, approximately in the same location as the existing driveway on that side of the project site.

Section D3 Massing and Scale

Policy D3-1: With the exception of areas identified as appropriate for significant increases in development intensity, as described in Chapter 2: Land Use Designations, respect the scale and character of existing residential developments in North Fair Oaks, by ensuring the massing and scale of new residential development complements existing structures and development patterns.

Section D4 Building Heights and Step backs

Policy D4-1: Require a 2-story minimum for all buildings within Neighborhood and Commercial Mixed-Use areas.

Staff's analysis: The project site is within one of the areas (Commercial Mixed-Use) described in Chapter 2 for increases in development intensity. The proposed building, at two stories tall, is consistent with adjacent buildings along 5th Avenue which are also, for the most part, two stories in height.

D6 Building Character and Façade Articulation

Policy D6-1: Prioritize articulation of façades along pedestrian-friendly corridors identified in the urban design framework in Chapter 2: Land Use Designations, such as Middlefield Road and key travel routes to nearby schools. Discourage blank walls along street-fronting façades on all streets.

Policy D6-2: Encourage varied building elements such as cornices, lintels, sills, balconies, awnings, porches, and stoops to enhance building façades.

Policy D6-3: Encourage vertical and horizontal architectural elements that mitigate long, unbroken building façades.

Policy D6-4: Encourage the use of building materials, forms and colors that provide visual interest to pedestrians and add variety to street edges.

Staff's analysis: The building has been designed with articulation on all four sides, but with particular emphasis upon the two street facing sides, where the wall profiles have been broken up with two story tall window bays, as well as the entry cupola/tower. The façade treatment also utilizes cornices, awnings, railings and external downspouts to break up the mass of each building wall. Horizontal elements, including lap siding along the upper third of each wall bordered by a belly band and horizontal trellises and railing, are

utilized along all four sides, again in an attempt to break up the mass of each building wall. The applicant is proposing to utilize a variety of materials, including galvanized steel for the bay window railings, cement plaster and fiber cement lap siding, as well as a varied color pallet for the building.

2. Compliance with Zoning Regulations

As stated previously, in January 2007 the project site was re-zoned to PUD-133 in order to accommodate a 10-unit townhome development. That project was never constructed and the associated subdivision map approval has expired. However, the unique PUD zoning remains in effect. Complicating this situation is the fact that the General Plan land use designation for this site has also changed as a result of the adoption of the North Fair Oaks Community Plan (discussed above). Compatible zoning to reflect the changes enacted in the new Community Plan are still being developed. Until such time that comprehensive new zoning regulations are adopted for the affected areas within the Community Plan, the only recourse to allow for new development to occur on the project site is to rezone it to a category that is compatible with that proposed use.

In order to understand the ramifications of this zoning change, Staff has assembled the following table comparing the proposed development to the existing PUD-133 standards:

Development Standard	PUD-133	Proposal
	Townhome Lots	Apartment Complex
Building Site Width (minimum average)	Average 20 feet	120 feet
Building Site Area (minimum)	Average 2,263 sq. ft.	18,011 sq. ft.
Minimum Lot Area Per Dwelling Unit	Average 2,263 sq. ft.	1,125 sq. ft.
Building Setbacks Front (Waverly Avenue): Side (interior): Side (Adj. to 5 th Ave.): Rear:	6 feet (to elevated patio) 20 feet (to building wall) 5 feet 10 feet 6 feet (to elevated patio) 20 feet (to building wall)	10 feet 9.33 feet (corner adj. to Waverly) 7.5 feet (corner adj. to parking lot) 10 feet 50 feet
Building Footprint Ratio	48.1 % for entire project site	36.8%
Building Height	35.33 feet, (two and a half stories)	25.5 ft. (top of the entry cupola)

		24 ft. (remainder of building)
Total Floor Area	22,630 sq. ft. (125.6% of parcel size)	12,382 sq. ft. (68.7% of parcel size)

Parcel Size: The previous PUD zoning would have subdivided the project site into ten residential lots with an additional common lot for landscaping and access. This would have meant working with ten different property owners and/or a property management company to address complaints (for example littering or unmaintained landscaping). With the current proposal, the property will be held by one entity, the Mental Health Association of San Mateo County, which should make tackling complaints easier to address.

Building Setbacks: As illustrated above, the current proposal will differ from the existing PUD-133 regulations, in particular along the side and rear property lines which abut existing residential development. The new proposal will provide greater setbacks in particular for residents of the apartment complex at 137 5th Avenue (located adjacent to the parking lot). The applicant is proposing to construct six foot tall solid fences along both property lines to help screen the building from these adjacent residential uses.

Building Footprint, Floor Area and Height: These three standards are commonly used to measure and regulate the overall bulk of urban development on a given parcel. As can be seen above, the proposed project will be significantly smaller in scale when compared to the previously approved townhome project. Of particular note is the difference in height, particularly for the single family residences that abut the site on the northwest side. Under the previous PUD zoning, those residences would have been facing an approximately 25 foot tall building wall with numerous windows and balconies facing into their back yards, all at approximately five feet from their property line. In contrast, the current proposal is setback somewhat farther (2.5 – five feet) and has a building wall height of only 18 feet. Additionally, the number of second story windows are substantially less and are associated with only one apartment in the building.

3. Compliance with Planned Unit Development (PUD) Findings

Section 6191 of the Zoning Regulations states that no PUD District shall be enacted for any area unless and until the Board of Supervisors has first:

Reviewed a precise plan of the subject area and its environs, and found that the proposed zoning of the area would be in harmony with said plan, and would not be in conflict with the County Master Plan (i.e., 1986 General Plan), or with any current land use plan for a sub-area of the County previously adopted by the Commission.

Staff Response: Based on the previous discussion in the North Fair Oaks Community Plan (NFOCP) Compliance Section of this report (Section A.1), staff concludes that the proposed PUD Zoning District regulations are in harmony with the applicable NFOCP policies.

Additional required findings listed below (italicized), stipulate that the Board of Supervisors must find that the specific PUD District:

- a. *Is a desirable guide for the future growth of the subject area of the County.*

Staff Response: As discussed under the Community Plan section above, the recently adopted Plan designates the project site as “Commercial Mixed-Use” which includes stand-alone high density residential as an allowed use. When the Plan was adopted it was fully anticipated that some of the designated land would be developed as high density apartments. As discussed above, the form of the building also complies with the architectural standards proposed in the Plan.

- b. *Will not be detrimental to the character, social and economic stability of the subject area and its environs, and will assure the orderly and beneficial development of such areas.*

Staff Response: Construction on this site with a new building, constructed to today’s building codes, will enhance the value of these parcels and the surrounding area. A well thought out and constructed apartment complex is of more value to the area than the existing vacant buildings which are not only an eyesore but also an attractive nuisance for vandalism. State and Federal law prohibits the County from discriminating against the potential future occupants of the units.

- c. *Will be in harmony with the zoning in adjoining unincorporated areas.*

Staff Response: The zoning in the surrounding unincorporated area includes R 1/S-73 to the rear of the proposed project, and C-1 in the area adjacent to the proposed project along Fifth Avenue. The neighborhood is generally bounded by Fifth Avenue to the south, the Caltrain railroad to the east, El Camino Real to the west and Berkshire Avenue to the north. The neighborhood is composed of commercial and apartment buildings along Fifth Avenue and single-family residential homes to the rear of the proposed development. The proposed project is an appropriate transition from the commercial uses on Fifth Avenue to the residential neighborhood to the rear, and provides additional housing for a particular population group where it is in high demand.

- d. *Will obviate the menace to the public safety resulting from land uses proposed adjacent to highways in the County, and will not cause undue interference with existing or prospective traffic movements on said highways.*

Staff Response: The major street that serves the project site, Fifth Avenue, is sufficiently improved and wide enough to accommodate the traffic volume that would be generated by this project. A traffic study prepared for this project (Attachment C) states:

The proposed project is conservatively estimated to generate approximately 18 trips during both the a.m. and p.m. peak hours based on ITE estimates and the conservative assumption that all 16 proposed residents would drive. Field surveys of a substantially similar Association residential site at 104 Cedar Street in Redwood City indicate that the proposed project trip estimate is conservatively high, given that few residents of this project type drive or own cars.

There is no reason to believe that the proposed project would adversely or significantly impact local or regional traffic patterns or volumes. Additionally, the project will provide the required one parking space per unit.

- e. *Will provide adequate light, air, privacy and convenience of access to the subject property and further that said property shall not be made subject to unusual or undue risk from fire, inundation, or other dangers.*

Staff Response: The project's overall site design, including the proposed buildings' location and setbacks relative to adjacent residences, provides adequate light, air, and privacy to neighboring uses.

- f. *Will not result in overcrowding of the land or undue congestion of population.*

Staff Response: The PUD provides a method for constructing higher density projects of this type in a controlled environment that ensures appropriate design. The proposed project is designed as a higher density residential development located between a major roadway and a lower density residential neighborhood. Due to the small size of the proposed project, it will not create overcrowding or undue congestion.

B. MAJOR DEVELOPMENT PRE-APPLICATION WORKSHOP

Section 6415.4 of the Zoning Regulations requires a public workshop to be held for residential development involving ten (10) or more new dwelling units. The

intent of the public workshop is to allow community members and public agency representatives the opportunity to provide the applicant with project input before the preparation of final development plans. The public workshop was held on March 5, 2014, at the Fair Oaks Community Center in North Fair Oaks.

C. STATE AND FEDERAL HOUSING LAW

In addition to the County regulations discussed above, there are several State and Federal laws that regulate the provision of housing for disabled persons, they include:

Prohibition of Discrimination Against Affordable Housing (Gov. Code Sec. 65008). This statute forbids discrimination against affordable housing developments, developers or potential residents by local agencies when carrying out their planning and zoning powers. Agencies are prohibited not only from exercising bias based on race, sex, age or religion, but from discriminating against developments because the development is subsidized or occupancy will include low or moderate income persons. Local governments may not impose different requirements on affordable developments than those imposed on non-assisted projects. It applies to any land use action that has a disproportionate impact on assisted developments or the potential minority or low income occupants. SB 619 (Ducheny) (Chapter 793, Statutes of 2003) prohibited discrimination against multifamily housing.

The California Fair Employment and Housing Act (Gov. Code Sec. 12900 et seq.) This statute expressly prohibits discrimination through public or private land use practices and decisions that make housing opportunities unavailable. Similarly, the federal Fair Housing Act (42 U.S.C. Sec. 3601 et seq., or "Title VIII") has been held to prohibit public and private land use practices and decisions that have a disparate impact on the protected groups. The federal Fair Housing Amendments Act of 1988 requires local governments considering housing projects for the disabled to make reasonable accommodations in rules, policies and practices if necessary to afford disabled persons equal opportunity for housing (42 U.S.C. Sec. 3604(f)(3)(B)).

D. ENVIRONMENTAL REVIEW

This project is Statutorily Exempt from the California Environmental Quality Act (CEQA) per Sections 15192 (Threshold Requirements For Exemptions For Agricultural Housing, Affordable Housing, And Residential Infill Projects) and 15194 (Affordable Housing Exemption) of the CEQA Guidelines. An analysis of project compliance with these exemption requirements is included in Attachment B.

ATTACHMENTS

- A. Recommended Findings and Conditions of Approval
- B. CEQA Statutory Exemption
- C. Project Traffic Impact Study (TJKM Transportation Consultants)

County of San Mateo
Planning and Building Department

RECOMMENDED FINDINGS AND CONDITIONS OF APPROVAL

Permit File Number: PLN 2014-00118

Hearing Date: October 8, 2014

Prepared By: Michael Schaller
Senior Planner

For Adoption By: Planning Commission

RECOMMENDED FINDINGS

Regarding the Environmental Review, Find:

1. That this project is Statutorily Exempt from the California Environmental Quality Act (CEQA) per Sections 15192 (Threshold Requirements For Exemptions For Agricultural Housing, Affordable Housing, And Residential Infill Projects) and 15194 (Affordable Housing Exemption) of the CEQA Guidelines.

Regarding the Planned Unit Development Zoning Amendment, Find:

2. That the proposed zoning of the area would be in harmony with said plan, and would not be in conflict with the County Master Plan (i.e., 1986 General Plan), or with any current land use plan for a sub-area of the County previously adopted by the Board, and that the specific PUD District under consideration, as discussed in Section A.3 of the staff report:
 - a. Is a desirable guide for the future growth of the subject area of the County.
 - b. Will not be detrimental to the character, social and economic stability of the subject area and its environs, and will assure the orderly and beneficial development of such areas.
 - c. Will be in harmony with the zoning in adjoining unincorporated areas.
 - d. Will obviate the menace to the public safety resulting from land uses proposed adjacent to highways in the County, and will not cause undue interference with existing or prospective traffic movements on said highways.
 - e. Will provide adequate light, air, privacy and convenience of access to the subject property and further that said property shall not be made subject to unusual or undue risk from fire, inundation, or other dangers.

- f. Will not result in overcrowding of the land or undue congestion of population.

RECOMMENDED CONDITIONS OF APPROVAL

Current Planning Section

1. This approval applies only to the proposal and plans, as conditioned in this report, and submitted to and approved by the Planning Commission. Minor adjustments to the project in the course of applying for building permits may be approved by the Community Development Director if they are consistent with the intent of and in substantial conformance with this approval.
2. Prior to pouring any concrete for foundations, written verification from a licensed surveyor will be required confirming that the setbacks, as shown on the approved plans, have been maintained.
3. Prior to building permit issuance, the applicant shall submit a lighting plan to the County Planning and Building Department, detailing the location and type of exterior lighting to be used in the project, and specifying the candle foot power of such lighting. The project will be required to maintain lighting levels such that the candle foot power of lighting generated on the project site shall not exceed one candle foot anywhere along the project perimeter. Lighting shall be confined to the project site only and shall not spillover onto adjoining properties.
4. Prior to the beginning of any construction activities, the applicant shall submit to the Planning Department for review and approval an erosion and drainage control plan which shows how the transport and discharge of soil and pollutants from and within the project site shall be minimized. The plan shall be designed to minimize potential sources of sediment, control the amount of runoff and its ability to carry sediment by diverting incoming flows and impeding internally generated flows, and retain sediment that is picked up on the project site through the use of sediment-capturing devices. The plan shall also limit application, generation, and migration of toxic substances, ensure the proper storage and disposal of toxic materials, apply nutrients at rates necessary to establish and maintain vegetation without causing significant nutrient runoff to surface waters. Said plan shall adhere to the San Mateo Countywide Stormwater Pollution Prevention Program "General Construction and Site Supervision Guidelines," including:
 - a. Sequence construction to install sediment-capturing devices first, followed by runoff control measures and runoff conveyances. No construction activities shall begin until after all proposed measures are in place.
 - b. Minimize the area of bare soil exposed at one time (phased grading).
 - c. Clear only areas essential for construction.

- d. Within five days of clearing or inactivity in construction, stabilize bare soils through either non-vegetative BMPs, such as mulching or vegetative erosion control methods such as seeding. Vegetative erosion control shall be established within two weeks of seeding/planting.
 - e. Construction entrances shall be stabilized immediately after grading and frequently maintained to prevent erosion and control dust.
 - f. Control wind-born dust through the installation of wind barriers such as hay bales and/or sprinkling.
 - g. Soil and/or other construction-related material stockpiled on-site shall be placed a minimum of 200 feet from all wetlands and drain courses. Stockpiled soils shall be covered with tarps at all times of the year.
 - h. Intercept runoff above disturbed slopes and convey it to a permanent channel or storm drains by using earth dikes, perimeter dikes or swales, or diversions. Use check dams where appropriate.
 - i. Provide protection for runoff conveyance outlets by reducing flow velocity and dissipating flow energy.
 - j. Install storm drain inlet protection that traps sediment before it enters any adjacent storm sewer systems. This barrier shall consist of filter fabric, straw bales, gravel, or sand bags.
 - k. Install sediment traps/basins at outlets of diversions, channels, slope drains, or other runoff conveyances that discharge sediment-laden water. Sediment traps/basins shall be cleaned out when 50% full (by volume).
 - l. Use silt fence and/or vegetated filter strips to trap sediment contained in sheet flow. The maximum drainage area to the fence should be 0.5 acres or less per 100 feet of fence. Silt fences shall be inspected regularly and sediment removed when it reaches 1/3 the fence height. Vegetated filter strips should have relatively flat slopes and be vegetated with erosion-resistant species.
 - m. Throughout the construction period, the applicant shall conduct regular inspections of the condition and operational status of all structural BMPs required by the approved erosion control plan.
5. The applicant shall submit a dust control plan to the Planning Department for review and approval prior to the issuance of a building permit for the project. The approved plan shall be implemented for the duration of any grading, demolition, and construction activities that generate dust and other airborne particles. The plan shall include the following control measures:

- a. Water all active construction areas at least twice daily.
 - b. Water or cover stockpiles of debris, soil, sand, or other materials that can be blown by the wind.
 - c. Cover all trucks hauling soil, sand and other loose materials or require all trucks to maintain at least 2 feet of freeboard.
 - d. Apply water three times daily, or apply (non-toxic) soil stabilizers on all unpaved access roads, parking and staging areas at construction sites. Also, hydroseed or apply non-toxic soil stabilizers to inactive construction areas.
 - e. Sweep daily (preferably with water sweepers) all paved access roads, parking and staging areas at construction sites.
 - f. Sweep adjacent public streets daily (preferably with water sweepers) if visible soil material is carried onto them.
 - g. Enclose, cover, water twice daily or apply non-toxic soil binders to exposed stockpiles (dirt, sand, etc.).
 - h. Limit traffic speeds on unpaved roads within the project parcel to 15 mph.
 - i. Install sandbags or other erosion control measures to prevent silt runoff to public roadways.
 - j. Replant vegetation in disturbed areas as quickly as possible.
6. All grading and construction activities associated with the project shall be limited to 7:00 a.m. to 6:00 p.m., Monday through Friday, and 9:00 a.m. to 5:00 p.m. on Saturday. Construction activities will be prohibited on Sunday and any nationally observed holiday. Noise levels produced by construction activities shall not exceed 80-dBA level at any one moment.
 7. Prior to submittal of plans for a building permit, the applicant shall revise their plans to include covered and screened bike parking. Said parking shall not reduce proposed front or side yard setbacks as depicted on the plans considered by the Planning Commission on October 8, 2014.

Building Inspection Section

8. The project shall comply with all 2013 California Building Codes.
9. No plastic Drain Waste Valve or water pipes are allowed except for storm drainage.

10. This is a publicly funded building, so ADA Sections 1109.A.4 and 1109A.8.691 shall apply. These sections require van parking and 1other handicap parking space; backing at all W/C and tub grab-bars. All rooms shall be H/C accessible.

Department of Public Works

11. Prior to the issuance of the Building permit or Planning permit (for Provision C3 Regulated Projects), the applicant shall have prepared, by a registered civil engineer, a drainage analysis of the proposed project and submit it to the Department of Public Works for review and approval. The drainage analysis shall consist of a written narrative & a plan. The flow of the stormwater onto, over, & off of the property shall be detailed on the plan and shall include adjacent lands as appropriate to clearly depict the pattern of flow. The analysis shall detail the measures necessary to certify adequate drainage. Post-development flows and velocities shall not exceed those that existed in the pre-developed state. Recommended measures shall be designed and included in the improvement plans and submitted to the Dept of Public Works for review and approval.
12. No proposed construction work within the County right-of-way shall begin until County requirements for the issuance of an encroachment permit, including review of the plans, have been met and an encroachment permit issued. Applicant shall contact a Department of Public Works Inspector 48 hours prior to commencing work in the right-of-way.
13. Prior to the issuance of the Building Permit, the applicant will be required to provide payment of "roadway mitigation fees" based on the square footage (assessable space) of the proposed building per Ordinance #3277.
14. For projects exceeding 10,000 square feet of new or reconstructed impervious surface: The applicant shall submit a permanent stormwater treatment plan in compliance with the County's National Pollution Discharge Elimination System (NPDES) permit for review and approval by the Department of Public Works. The applicant shall submit calculations and a narrative describing the method(s) used in the design of the proposed system and the manner in which proposed facilities achieve compliance with the NPDES permit for review and approval by the Department of Public Works. The applicant shall be required to execute and record an Operations and Maintenance Agreement for the approved facilities, and shall be responsible for ongoing maintenance and reporting. This requirement supplements all other conditions of approval related to storm drainage and stormwater pollution prevention.

Menlo Park Fire Protection District

15. Install a monitored NFPA 13 fire sprinkler, NFPA 24 underground fire service and a NFPA 27 fire alarm system under separate fire permit. Fire sprinkler system to comply with Menlo Park Fire Protection District Standards.

16. Install one new public fire hydrant near site for this project.
17. Install a smoke detector and carbon monoxide detector in each sleeping area. Smoke and carbon monoxide detectors shall be inter-connected for alarm in each separate unit.
18. If an elevator is installed the car must be sized to accommodate a medical stretcher and two attending EMS personnel.
19. The applicant shall provide at least 6 inch tall with 3/4 inch stroke illuminated address numbers. The address shall be visible from the street and contrasting to its background.
20. Approved plans and approval letter must be on site at the time of inspection.
21. Final acceptance of this project is subject to field inspection. Upon completion of work and prior to closing ceiling, **contact Fire Inspector Bob Blach of the Menlo Park Fire Protection District at 650-688-8430 to schedule a final inspection.**
48 HOURS NOTICE IS REQUIRED FOR ALL INSPECTIONS.

In order to qualify for an exemption from the California Environmental Quality Act (CEQA), this project must first qualify under the threshold requirements outlined in Section 15192 and then the specific requirements outlined in Section 15194. Compliance with each Section is discussed below:

Section 15192. THRESHOLD REQUIREMENTS FOR EXEMPTIONS FOR AGRICULTURAL HOUSING, AFFORDABLE HOUSING, AND RESIDENTIAL INFILL PROJECTS

In order to qualify for an exemption set forth in sections 15193, 15194 or 15195, a housing project must meet all of the threshold criteria set forth below.

(a) The project must be consistent with:

1. Any applicable general plan, specific plan, or local coastal program, including any mitigation measures required by such plan or program, as that plan or program existed on the date that the application for the project pursuant to Section 65943 of the Government Code was deemed complete; and

Staff Analysis: Staff has reviewed the proposed project against the applicable policies of the North Fair Oaks Community Plan (NFOCP) and found the project is consistent, as discussed in the staff report for PLN 2014-00118.

2. Any applicable zoning ordinance, as that zoning ordinance existed on the date that the application for the project pursuant to Section 65943 of the Government Code was deemed complete, unless the zoning of project property is inconsistent with the general plan because the project property has not been rezoned to conform to the general plan.

Staff Analysis: The existing zoning of the project site, PUD-133, is not consistent with the land use designation that was placed on the site by the NFOCP. The proposed project is a rezoning of the site to a designation that would be compatible with this designation. Rezoning to implement the Community Plan is scheduled to occur in 2015.

(b) Community-level environmental review has been adopted or certified.

Staff Analysis: An Environmental Impact Report (Final Environmental Impact Report – North Fair Oaks Community Plan Update, State Clearinghouse #2011042099) was certified for the NFOCP by the Board of Supervisors on November 15, 2011.

(c) The project and other projects approved prior to the approval of the project can be adequately served by existing utilities, and the project applicant has paid, or has committed to pay, all applicable in-lieu or development fees.

Staff Analysis: Water and Sewer mains adequate to meet the demands of the proposed project are in place within the adjacent streets. Both systems have sufficient capacity to serve this proposed project. The applicant has included the cost of connections to these two systems in their overall budget for this project.

(d) The site of the project:

1. Does not contain wetlands, as defined in Section 328.3 of Title 33 of the Code of Federal Regulations.

Staff Analysis: There are no wetlands or other natural water bodies on or near the project site. The project site is almost entirely paved over at the present time.

2. Does not have any value as an ecological community upon which wild animals, birds, plants, fish, amphibians, and invertebrates depend for their conservation and protection.

Staff Analysis: The project site is within a highly developed urban neighborhood. There is no natural vegetation on the project site that could support an ecological community.

3. Does not harm any species protected by the federal Endangered Species Act of 1973 (16 U.S.C. Sec. 1531 et seq.) or by the Native Plant Protection Act (Chapter 10 (commencing with Section 1900) of Division 2 of the Fish and Game Code), the California Endangered Species Act (Chapter 1.5 (commencing with Section 2050) of Division 3 of the Fish and Game Code).

Staff Analysis: As stated previously, there is no natural habitat remaining on the parcel. No listed plant or animal species have been identified on or near the project site.

4. Does not cause the destruction or removal of any species protected by a local ordinance in effect at the time the application for the project was deemed complete.

Staff Analysis: No locally protected plant or animal species have been identified on or near the project site.

(e) The site of the project is not included on any list of facilities and sites compiled pursuant to Section 65962.5 of the Government Code.

Staff Analysis: The project site is not on the Calif. Department of Toxic Substance Control's Hazardous Waste and Substances Site List.

(f) The site of the project is not subject to a preliminary endangerment assessment prepared by a registered environmental assessor to determine the existence of any

release of a hazardous substance on the site and to determine the potential for exposure of future occupants to significant health hazards from any nearby property or activity. In addition, the following steps have been taken in response to the results of this assessment:

Staff Analysis: The site is not known to contain or have a history of containing hazardous materials. There is no evidence to suggest that future occupants will be exposed to health hazards from nearby property or activities.

- (g) The project does not have a significant effect on historical resources pursuant to Section 21084.1 of the Public Resources Code.

Staff Analysis: There are no identified historical resources on the project site.

- (h) The project site is not subject to wildland fire hazard, as determined by the Department of Forestry and Fire Protection, unless the applicable general plan or zoning ordinance contains provisions to mitigate the risk of a wildland fire hazard.

Staff Analysis: The project site is not within a designated Wildland Fire Hazard Zone.

- (i) The project site does not have an unusually high risk of fire or explosion from materials stored or used on nearby properties.

Staff Analysis: Residential uses adjoin the project parcel on the north and west side. The Fifth Avenue right-of-way is to the east. To the south are neighborhood commercial uses. There is no evidence that there is an adjacent use that could generate an unusually high risk of fire or explosion.

- (j) The project site does not present a risk of a public health exposure at a level that would exceed the standards established by any state or federal agency.

Staff Analysis: There is no evidence to suggest that the project site is at risk of a higher exposure than any of the adjacent residential uses.

- (k) Either the project site is not within a delineated earthquake fault zone or a seismic hazard zone, as determined pursuant to Section 2622 and 2696 of the Public Resources Code respectively, or the applicable general plan or zoning ordinance contains provisions to mitigate the risk of an earthquake or seismic hazard.

Staff Analysis: The nearest delineated earthquake fault zone or seismic hazard zone is the San Andreas Fault zone, which is approximately five miles west of the project site.

- (l) Either the project site does not present a landslide hazard, flood plain, flood way, or restriction zone, or the applicable general plan or zoning ordinance contains provisions to mitigate the risk of a landslide or flood.

Staff Analysis: The project site is flat and not within a landslide hazard zone, nor is it within a mapped flood plain or other flood hazard zone.

- (m) The project site is not located on developed open space.

Staff Analysis: The project site has historically been used for commercial retail use (doors and windows for home construction/remodeling). There is no developed open space in the immediate project vicinity.

- (n) The project site is not located within the boundaries of a state conservancy.

Staff Analysis: There are no state conservancies near the project site.

- (o) The project has not been divided into smaller projects to qualify for one or more of the exemptions set forth in sections 15193 to 15195.

Staff Analysis: The project has not been divided into smaller projects. The project under consideration constitutes the entirety of the activities and structures proposed for the project site.

Section 15194. AFFORDABLE HOUSING EXEMPTION

CEQA does not apply to any development project that meets the following criteria:

- (a) The project meets the threshold criteria set forth in section 15192.

Staff Analysis: The project meets the threshold criteria as described above.

- (b) The project meets the following size criteria: the project site is not more than five acres in area.

Staff Analysis: The project site is 18,011 sq. ft. (0.41 acres) in size.

- (c) The project meets both of the following requirements regarding location:

- (1) The project meets one of the following location requirements relating to population density:

- (A) The project site is located within an urbanized area or within a census-defined place with a population density of at least 5,000 persons per square mile.

Staff Analysis: The project site is within an urbanized area. The site is surrounded by urban density residential use on two sides and neighborhood commercial uses on a third side.

- (B) If the project consists of 50 or fewer units, the project site is located within an incorporated city with a population density of at least 2,500 persons per square mile and a total population of at least 25,000 persons.

Staff Analysis: The project site is within an unincorporated pocket adjacent to Redwood City which has a population of 79,000.

- (C) The project is located within either an incorporated city or a census defined place with a population density of at least 1,000 persons per square mile and there is no reasonable possibility that the project would have a significant effect on the environment or the residents of the project due to unusual circumstances or due to the related or cumulative impacts of reasonably foreseeable projects in the vicinity of the project.

Staff Analysis: See above.

- (2) The project meets one of the following site-specific location requirements:

- (A) The project site has been previously developed for qualified urban uses; or

Staff Analysis: The site has been previously developed with a commercial use (home construction supplies). There are three vacant buildings on the project site at the present time.

- (B) The parcels immediately adjacent to the project site are developed with qualified urban uses.

Staff Analysis: The project site is bordered by residential uses on two sides, commercial uses on a third side, and a large thoroughfare on the last side.

- (C) The project site has not been developed for urban uses and all of the following conditions are met:

1. No parcel within the site has been created within 10 years prior to the proposed development of the site.
2. At least 75 percent of the perimeter of the site adjoins parcels that are developed with qualified urban uses.
3. The existing remaining 25 percent of the perimeter of the site adjoins parcels that have previously been developed for qualified urban uses.

Staff Analysis: Not applicable. See above discussion.

(d) The project meets both of the following requirements regarding provision of affordable housing:

(1) The project consists of the construction, conversion, or use of residential housing consisting of 100 or fewer units that are affordable to low-income households.

Staff Analysis: The project consists of a 16-unit apartment complex to be developed by the Mental Health Association of San Mateo County.

(2) The developer of the project provides sufficient legal commitments to the appropriate local agency to ensure the continued availability and use of the housing units for lower income households for a period of at least 30 years, at monthly housing costs deemed to be “affordable rent” for lower income, very low income, and extremely low income households, as determined pursuant to Section 50053 of the Health and Safety Code.

Staff Analysis: The project parcels and the proposed building are and will be owned by the Mental Health Association of San Mateo County. The Association has received public funds to assist in the purchase of this land and the construction of the building. The Association is party to the “Agreement with Mental Health Association of San Mateo County (MHA) for Funds to Acquire 105 5th Avenue”, by and between the City of Redwood City (City) and MHA approved by Redwood City Resolution No. 15282 dated July 22, 2013, including the Declaration of Affordability Covenants and Deed of Trust.



Transportation
Consultants

Vision That Moves Your Community

August 21, 2014

Shane Young
Programs Assistant
Mental Health Association of San Mateo County
2686 Spring Street
Redwood City, CA 94063

Via email only: ShaneY@mhasmc.org

Re: Final Focused Traffic Impact Study for Proposed Waverly Place Affordable Residential Housing Development

Dear Mr. Young:

TJKM Transportation Consultants is pleased to present the results of its focused traffic study for the Waverly Place Affordable Residential Housing Development at 105 Fifth Avenue in the unincorporated North Fair Oaks area of the County of San Mateo. The proposed project is to be located at the north corner of the intersection of Fifth Avenue and Waverly Avenue. Per the proposed project's site plan, the project consists of 16 apartments (15 studio units for residents and a one-bedroom unit for the property manager), four offices used by part-time staff, and a community space. In addition to the property manager, part-time staff includes a case manager and two other staff members who visit the site. The onsite offices would be used no more than 20 hours per week per each staff member. TJKM understands that the apartments are intended to serve adults living with mental illness, and most residents would not drive or own a car. However, per County of San Mateo staff direction, TJKM has conservatively assumed that all residents would drive and own a car for the purposes of this study.

The purpose of this traffic study is to evaluate the potential traffic impacts the proposed project could have on the adjacent roadway network; identify roadway/circulation needs; determine potential mitigation measures; and identify any critical circulation issues that should be addressed in the ongoing planning process.

This study includes an analysis of three study intersections under two study scenarios - Existing Conditions and Existing plus Project Conditions. Figure 1 shows the location of the project site, the project's vicinity, and the study intersections. Figure 2 shows the proposed site plan. All referenced figures and appendices are included as attachments at the end of this report.

Analysis of Potential Traffic Impacts

Intersection Methodology

The Highway Capacity Manual 2000 Operations Method incorporated in Synchro 8 traffic software is used in this study to evaluate the Levels of Service (LOS) at the following three study intersections:

1. Fifth Avenue / Waverly Avenue
2. Fifth Avenue / El Camino Real
3. Fifth Avenue / Middlefield Road

The operating conditions at these study intersections are evaluated for the two following scenarios:

1. Existing Conditions – this scenario evaluates the study intersections based on existing 2014 roadway conditions and a.m. and p.m. peak hour turning movement counts collected at the study intersections on typical weekdays.
2. Existing plus Proposed Project Conditions – this scenario is similar to the *Existing Conditions* scenario, but with the addition of traffic expected to be generated by the proposed project at 105 Fifth Avenue.

The County of San Mateo Traffic Impact Study Requirements (2013) state that the minimum acceptable service level is LOS C, with no individual movement operating worse than LOS D. LOS D operations may be allowed, per County's discretion, under dense urban conditions during peak periods. Based on discussion with County staff, LOS D is considered to be the significance threshold for the study intersections since the project is located within an urban area of the County. At intersections that currently operate at an unacceptable LOS, the County guidelines state that a project is considered to have a significant impact if the intersection continues to operate at an unacceptable LOS and the average control delay increases by four seconds or more.

Existing Conditions

TJKM collected vehicle, bicycle, and pedestrian counts at the study intersections on typical weekdays in March and April 2014. These counts are included in Appendix A. Figure 3 shows the existing peak hour vehicle turning movement counts at the study intersections, as well as current lane configurations and traffic controls.

Table I summarizes the average delay, volume-to-capacity ratio, and LOS experienced at each approach and lane group at the study intersections, as well as the overall intersection, under Existing Conditions during the a.m. and p.m. peak hours. LOS analysis sheets are contained in Appendix B. All study intersections currently operate at acceptable LOS overall, during both the a.m. and p.m. peak hours. In terms of the approaches and lane groups at the study intersections, all operate acceptably, with the following exceptions:

- Fifth Avenue / Middlefield Road
 - Northbound Left-Turn, Through, and Right-Turn lane group
 - LOS E during the a.m. peak hour
 - LOS F during the p.m. peak hour
 - Southbound Left-Turn, Through, and Right-Turn lane group
 - LOS E during the a.m. peak hour

Table I: Intersection Levels of Service – Existing Conditions

ID	Intersection	Control	Approach/Lane Group		A.M. Peak Hour			P.M. Peak Hour		
					Delay	v/c	LOS	Delay	v/c	LOS
1	Fifth Avenue / Waverly Avenue	Signal	SE - Waverly	LT-RT	20.2	0.22	C	22.1	0.33	C
			NE - Fifth	LT-TH	2.8	0.37	A	2.3	0.39	A
			SW - Fifth	TH-RT	3.2	0.47	A	2.2	0.37	A
			Overall Intersection		3.6	0.44	A	2.9	0.38	A
2	Fifth Avenue / El Camino Real	Signal	SE - El Camino	LT	41.6	0.94	D	46.2	0.92	D
			SE - El Camino	TH	9.2	0.58	A	5.4	0.31	A
			NW - El Camino	TH-RT	23.1	0.71	C	26.6	0.91	C
			SW - Fifth	LT	52.9	0.97	D	33.0	0.75	C
			SW - Fifth	RT	6.7	0.43	A	15.9	0.68	B
			Overall Intersection		21.9	0.88	C	22.7	0.87	C
3	Fifth Avenue / Middlefield Road	Signal	N - Fifth	LT-TH-RT	72.0	0.99	E	102.8	1.10	F
			S - Fifth	LT-TH-RT	70.9	0.99	E	51.3	0.89	D
			SE - Middlefield	LT-TH-RT	42.3	0.87	D	37.5	0.81	D
			NW - Middlefield	LT-TH-RT	28.2	0.44	C	30.7	0.63	C
			Overall Intersection		52.5	0.95	D	53.6	0.93	D

- Notes: 1) Delay = Average Delay in seconds per vehicle
2) v/c = Volume-to-Capacity Ratio
3) LOS = Level of Service
4) **Bold** indicates LOS exceeds applicable standard for operating conditions.
5) LT-TH-RT = Left-Turn, Through, Right-Turn movement
6) SE = southeast, NE = northeast, SW = southwest, NW = northwest, N = north, S = south

Trip Generation

Trip generation for the proposed project is estimated based on County direction for the residential component of the project and trip rates contained in *Trip Generation*, 9th Edition, published by the Institute of Transportation Engineers (ITE) for the office component of the project. The 16 studio apartments and the four offices of the proposed project at 105 Fifth Avenue are expected to generate approximately 18 trips during the a.m. peak hour and 18 trips during the p.m. peak hour. Table II shows the expected trip generation for each land use.

Per County direction, for conservative purposes, each resident of the proposed project is assumed to own a car and to drive during both peak hours. According to the applicant, a maximum of one resident would live in each unit. For the analysis, TJKM assumed all residents would leave the project site in the a.m. peak hour (16 outbound trips) and return in the p.m. peak hour (16 inbound trips). It should be noted that this residential vehicle trip total represents a conservative (worst-case) estimate. In practice, residential developments of this type would generate fewer trips as very few residents typically drive or own cars. TJKM also conservatively estimated that the project's four offices would generate vehicle trips during typical weekday a.m. and p.m. peak hours, when in practice this would be less likely as on-site staff will only be part-time and few would travel to and from the site during peak hours. In addition, the applicant expects to hold occasional meetings in the community space of the proposed project. These meetings are expected to occur typically between 2 p.m. and 3:30 p.m., and therefore are not expected to generate vehicle trips during typical weekday a.m. and p.m. peak hours.

A housing development substantially similar in size and intended use to the proposed project is operated by the Association at 104 Cedar Street in Redwood City, CA. This development consists of 15 apartments (14 studios and a one-bedroom) and two offices. TJKM observed the development's driveway on a typical weekday in April 2014 and counted seven vehicle trips in the a.m. peak hour and three vehicle trips in the p.m. peak hour generated to/from the site, totals that are significantly lower than the trips (18 for both a.m. and p.m. peak hours) estimated in this study.

Table II: Peak Hour Trip Generation for Proposed Project

Land Use (ITE Code)	Size	A.M. Peak Hour					P.M. Peak Hour				
		Rate	In: Out (%)	In	Out	Total	Rate	In: Out (%)	In	Out	Total
Apartment (See Note 1 below.)	16 Dwelling Units	1.00	0:100	0	16	16	1.00	100:0	16	0	16
General Office (710)	1.12 KSF Gross Floor Area	1.56	88:12	2	0	2	1.49	17:83	0	2	2
Total				2	16	18			16	2	18

- Notes:
- 1) Per County direction, for conservative purposes, each resident of the proposed project is assumed to own a car and to drive during both peak hours, with all residents leaving the project site in the a.m. peak hour and returning in the p.m. peak hour.
 - 2) For the office component of the trip generation, the source of the trip rates is Trip Generation, 9th Edition, Institute of Transportation Engineers
 - 3) KSF = 1,000 SF

Project Trip Distribution and Assignment

The process of trip distribution determines the proportion of project trips that are expected to travel between the project site and various destinations outside the project area. Trip assignment determines the various routes that vehicles are expected to take while travelling between the project site and each destination. For the proposed project, the trip distribution and assignment were determined based on existing turning movements, TJKM's knowledge of the study area, the location of the proposed project driveway on Fifth Avenue, and consultation with County staff. The assumed distribution percentages are as follows:

- 35 percent to/from the northwest via El Camino Real
- 24 percent to/from the northwest via Middlefield Road
- 24 percent to/from the north via Fifth Avenue
- 15 percent to/from the southwest via El Camino Real
- 2 percent to/from the southwest via Middlefield Road

Figure 4 shows the assumed trip distribution percentages and the trip assignments at the study intersections based on these percentages.

Existing plus Project Conditions

Figure 5 shows the expected peak hour vehicle turning movement volumes at the study intersections under the Existing plus Project Conditions scenario. Table III compares the average delay, volume-to-capacity ratio, and LOS for each approach and lane group at the study intersections (and also the overall intersection) under Existing Conditions and Existing plus Project Conditions during the a.m. and p.m. peak hours. LOS analysis sheets are contained in Appendix C. All study intersections are expected to remain operating at acceptable LOS per County standards of LOS D or better overall, with minimal changes in

average delay. In terms of the approaches and lane groups at the study intersections, all are expected to continue operating acceptably, with the following exceptions:

- Fifth Avenue / Middlefield Rd
 - Northbound Left-Turn, Through, and Right-Turn lane group
 - LOS E during the a.m. peak hour with increase of 5.3 seconds delay
 - LOS F during the p.m. peak hour with increase of 2.3 seconds delay
 - Southbound Left-Turn, Through, and Right-Turn lane group
 - LOS E during the a.m. peak hour with increase of 0.4 seconds delay

Table III: Intersection Levels of Service – Existing plus Project Conditions

ID	Inter-section (Control)	Approach/ Lane Group		Existing Conditions						Existing plus Project Conditions					
				A.M. Peak Hour			P.M. Peak Hour			A.M. Peak Hour			P.M. Peak Hour		
				Delay	v/c	LOS	Delay	v/c	LOS	Delay	v/c	LOS	Delay	v/c	LOS
1	Fifth Avenue / Waverly Avenue (Signal)	SE - Waverly	LT-RT	20.2	0.22	C	22.1	0.33	C	20.2	0.22	C	22.1	0.33	C
		NE - Fifth	LT-TH	2.8	0.37	A	2.3	0.39	A	2.8	0.37	A	2.3	0.39	A
		SW - Fifth	TH-RT	3.2	0.47	A	2.2	0.37	A	3.2	0.47	A	2.2	0.37	A
		Overall Intersection		3.6	0.44	A	2.9	0.38	A	3.6	0.44	A	2.9	0.38	A
2	Fifth Avenue / El Camino Real (Signal)	SE - El Camino	LT	41.6	0.94	D	46.2	0.92	D	41.8	0.94	D	47.7	0.93	D
		SE - El Camino	TH	9.2	0.58	A	5.4	0.31	A	9.2	0.58	A	5.4	0.31	A
		NW - El Camino	TH-RT	23.1	0.71	C	26.6	0.91	C	23.1	0.71	C	26.7	0.91	C
		SW - Fifth	LT	52.9	0.97	D	33.0	0.75	C	53.7	0.98	D	33.0	0.75	C
		SW - Fifth	RT	6.7	0.43	A	15.9	0.68	B	6.7	0.44	A	15.9	0.68	B
Overall Intersection		21.9	0.88	C	22.7	0.87	C	22.0	0.88	C	23.0	0.87	C		
3	Fifth Avenue / Middlefield Road (Signal)	N - Fifth	LT-TH-RT	72.0	0.99	E	102.8	1.10	F	77.3	1.01	E	105.1	1.11	F
			LT-TH (mit)	-	-	-	-	-	-	61.5	0.95	E	-	-	-
			RT (mit)	-	-	-	-	-	-	24.6	0.02	C	-	-	-
		S - Fifth	LT-TH-RT (with NB mit)	70.9	0.99	E	51.3	0.89	D	71.3	0.99	E	51.8	0.90	D
			-	-	-	-	-	-	69.3	0.99	E	-	-	-	
		SE - Middlefield	LT-TH-RT (with NB mit)	42.3	0.87	D	37.5	0.81	D	42.3	0.87	D	38.0	0.81	D
			-	-	-	-	-	-	41.7	0.86	D	-	-	-	
		NW -Middlefield	LT-TH-RT (with NB mit)	28.2	0.44	C	30.7	0.63	C	28.2	0.44	C	31.0	0.64	C
			-	-	-	-	-	-	27.9	0.44	C	-	-	-	
		Overall Intersection (with NB mit)		52.5	0.95	D	53.6	0.93	D	53.8	0.95	D	54.4	0.94	D
-		-	-	-	-	-	-	49.2	0.93	D	-	-	-		

- Notes:
- 1) Delay = Average Delay in seconds per vehicle
 - 2) v/c = Volume-to-Capacity Ratio
 - 3) LOS = Level of Service
 - 4) **Bold** indicates LOS exceeds applicable standard for operating conditions.
 - 5) LT-TH-RT = Left-Turn, Through, Right-Turn
 - 6) mit = Mitigation
 - 7) *Italics* indicates lane group and LOS results at study intersection 3, during the a.m. peak hour, for mitigation to stripe the northbound approach (Fifth Avenue) with a shared left turn-through lane and a 90' northbound right-turn lane pocket.

Under Existing plus Project Conditions, an impact due to the proposed project traffic is expected for the northbound lane group at the Fifth Avenue / Middlefield Road intersection, with delay estimated to increase by 5.3 seconds during the a.m. peak hour. This impact is expected to be mitigated to a less than significant level by restriping the northbound approach to a shared left turn-through lane and a 90-foot long right-turn pocket. This mitigation is expected to be feasible within the current pavement width given that parking is currently prohibited during a.m. and p.m. peak periods at the northbound approach.

Alternative Transportation

Existing and Proposed Transit Facilities

TJKM reviewed the availability of transit services within the study area for project residents and employees. Within a quarter-mile of the proposed project site, SamTrans provides one bus route: Route ECR. Route ECR runs along El Camino Real in the vicinity of the project site, to/from the Daly City BART station to the north of the project site, and to/from the Palo Alto Transit Center to the south. A bus stop for northbound service of Route ECR is at the intersection of El Camino Real and Amherst Avenue and the service has approximately 15-minute headways in both the weekday a.m. and p.m. peak hours. A bus stop for southbound service of Route ECR is at the intersection of El Camino Real and Fifth Avenue and the service has approximately 15-minute headways in both the weekday a.m. and p.m. peak hours.

Within an additional quarter-mile (a half-mile in total) of the proposed project site, SamTrans provides three additional bus routes: Route 296, 297, and 397. Route 296 runs along Middlefield Road in the vicinity of the project site, to/from the Redwood City Caltrain Station north of the project site, and to/from the shopping center at E. Bayshore Road and Donohoe Street to the south. Route 297 runs along Middlefield Road in the vicinity of the project site, to/from the Redwood City Caltrain Station north of the project site, and to/from the Palo Alto Transit Center to the south. Route 397 runs along Middlefield Road in the vicinity of the project site, to/from Downtown San Francisco to the north of the project site, and to/from the Palo Alto Transit Center to the south.

Bus stops for both northbound and southbound service of Routes 296, 297, and 397 are at the intersection of Middlefield Road and Fifth Avenue. Northbound and southbound service for Route 296 both have approximately 15-minute headways in both the weekday a.m. and p.m. peak hours. The only service provided for Route 297 during the weekday peak hours is northbound service with one-hour headways during the weekday p.m. peak hour. Route 397 does not offer service during the weekday peak hours near the proposed project site.

In the future, the North Fair Oaks Community Plan (2011) identifies additional local bus and shuttle service along Fifth Avenue and streetcar service along Middlefield Road north of Fifth Avenue and along Fifth Avenue east of Middlefield Road.

The existing and proposed transit facilities in the area of the proposed project will provide an alternative to driving for project residents and employees. Due to the very low trip generation of the proposed project, there are no known impacts of the proposed project on the transit network.

Existing and Proposed Pedestrian Facilities

Sidewalks are provided on both sides of Waverly Avenue and Fifth Avenue adjacent to and in the vicinity of the proposed project site. The sidewalks on Fifth Avenue extend to the west to El Camino Real. To the east, a continuous pedestrian path is provided to Middlefield Road via

crosswalks, ramps, a pedestrian underpass under the Caltrain tracks, and sidewalks along Williams Avenue and Semicircular Road.

Sidewalks are also provided on the east side of El Camino Real at its intersection with Fifth Avenue and both sides of all approaches to the intersection of Middlefield Road and Fifth Avenue. Bulbouts are also provided at each end of the crosswalk across the south leg of Middlefield Road at Fifth Avenue.

Audible and countdown-type pedestrian signals are provided for each crosswalk at the intersections of Fifth Avenue and Waverly Avenue and Fifth Avenue and Middlefield Road. Audible and countdown-type pedestrian signals are not currently provided at the intersection of Fifth Avenue and El Camino Real.

The proposed project will provide walkways from building access points to the existing continuous sidewalks along the frontage of the development on both Fifth Avenue and Waverly Avenue. The project connections would enhance existing pedestrian facilities in the area, and there are no known impacts of the proposed project on the pedestrian network.

Existing and Proposed Bicycling Facilities

Near the project site, Fifth Avenue is grade separated under the Caltrain right-of-way and also includes two frontage roads that allow vehicles full access to both directions of Fifth Avenue. Class II bikeways (on-street bicycle lanes) are currently striped along both sides of the Fifth Avenue alignment underneath Caltrain between Waverly Avenue and Semicircular Road.

The San Mateo County Comprehensive Bicycle and Pedestrian Plan (2011) proposes Class II bikeways along Fifth Avenue, between Semicircular Road and El Camino Real and along Middlefield Road, between Semicircular Road and Fifth Avenue. The Bicycle and Pedestrian Plan also proposes Class III bikeways (signed bicycle routes) along Middlefield Road north of Fifth Avenue, Fifth Avenue east of Middlefield Road, and along El Camino Real north and south of Fifth Avenue.

The existing and proposed bicycle facilities in the area of the proposed project provide an alternative to driving. There are no known impacts of the proposed project on the current bicycle network.

Site Access

The site plan for the proposed project shows the project driveway to be approximately 110 feet northeast of Waverly Avenue along the west side frontage road of Fifth Avenue. At the project driveway, this frontage road and the main alignment of Fifth Avenue are separated by a raised concrete median. At the driveway, traffic on the branch transitions from one-way southbound traffic south of the driveway to two-way traffic north of the driveway. Project traffic is afforded full access to both directions of Fifth Avenue via the frontage roads.

On-site Parking

The County of San Mateo Zoning Regulations (December 2012) require one parking space to be provided for each apartment. The site plan for the proposed project shows 16 spaces, which meets County requirements.

However, it should be noted that the demand for vehicular parking is expected to be considerably less than what is required by the County code. The proposed project would provide nearly twice as much onsite parking as the Association's substantially similar housing development at 104 Cedar Street, which provides eight on-site parking spaces for its 15 apartments and 2 offices. On a typical

weekday evening in April 2014, TJKM observed a maximum demand of six vehicles parked at the Cedar Street site. Based on this field survey of a substantially similar development to the proposed project, TJKM anticipates a similar maximum parking demand of six vehicles at the proposed project site. That demand would be easily met by the 16 proposed parking spaces onsite, with surplus onsite parking available.

Conclusions and Recommendations

- Under Existing Conditions, all study intersections operate acceptably at LOS D or better overall, which meets San Mateo County requirements for urban County intersections. In terms of the critical approaches and lane groups at the study intersections, all operate acceptably, with the exception of the northbound and southbound approaches at the Fifth Avenue / Middlefield Road intersection. The northbound approach currently operates at LOS E and LOS F in the a.m. and p.m. peak hours, respectively. The southbound approach currently operates at LOS E in the a.m. peak hour.
- The proposed project is conservatively estimated to generate approximately 18 trips during both the a.m. and p.m. peak hours based on ITE estimates and the conservative assumption that all 16 proposed residents would drive. Field surveys of a substantially similar Association residential site at 104 Cedar Street in Redwood City indicate that the proposed project trip estimate is conservatively high, given that few residents of this project type drive or own cars.
- Under Existing plus Project Conditions, the study intersections are expected to continue operating acceptably at LOS D or better overall, with minimal changes in average delay. Except for the northbound approach at the Fifth Avenue/ Middlefield Road intersection during the a.m. peak hour, the delay does not increase by four or more seconds for critical movements that operate at an unacceptable LOS under Existing Conditions. To mitigate the expected a.m. peak hour increase of 5.3 seconds at the northbound approach of the Fifth Avenue / Middlefield Road intersection expected to continue operating at LOS E, it is proposed to restripe the approach to a shared left turn-through lane and a 90-foot long right-turn pocket. The result would be an average delay for this approach that is lower than the delay under Existing Conditions.
- The existing and proposed transit, pedestrian, and bicycling facilities in the area of the proposed project provide an alternative to driving. There are no known impacts that the proposed project would create for any of these modes.
- The site plan for the proposed project shows that 16 parking spaces will be provided for project vehicles, which meets County requirements.. However, TJKM field surveys of the Association's substantially similar development at 104 Cedar Street in Redwood City indicate that the project parking supply well exceeds typical residential evening demand (six vehicles maximum) and at the same time would accommodate daytime demand for part-time workers on site, with surplus onsite parking available.

TJKM appreciates the opportunity to provide you with this traffic impact study. If you have any questions concerning this study, please call us at (925) 463-0611.

Sincerely,

Andrew Kluter, P.E.
Project Manager

Travis Richards, P.E.
Senior Transportation Engineer

Attachments

Figure 1: Vicinity Map

Figure 2: Site Plan

Figure 3: Existing Conditions Traffic Volumes, Lane Geometry, and Traffic Controls

Figure 4: Project Distribution and Assignment

Figure 5: Existing plus Project Conditions Traffic Volumes, Lane Geometry, and Traffic Controls

Appendix A: Existing Turning Movement Counts

Appendix B: LOS Analysis Sheets (Existing Conditions)

Appendix C: LOS Analysis Sheets (Existing plus Project Conditions)

San Mateo County - TIS for Waverly Place Affordable Housing Development Vicinity Map

Figure
1

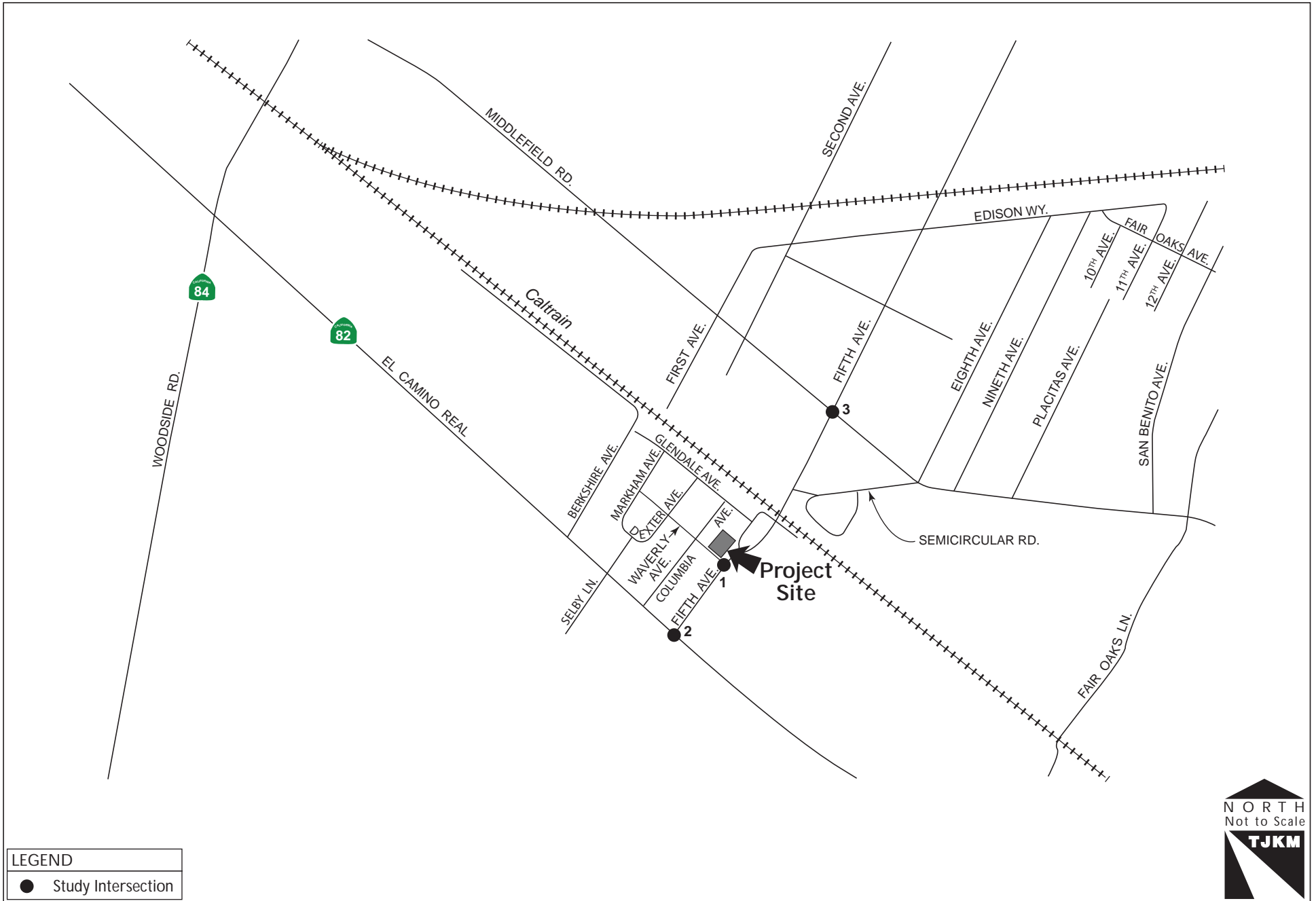

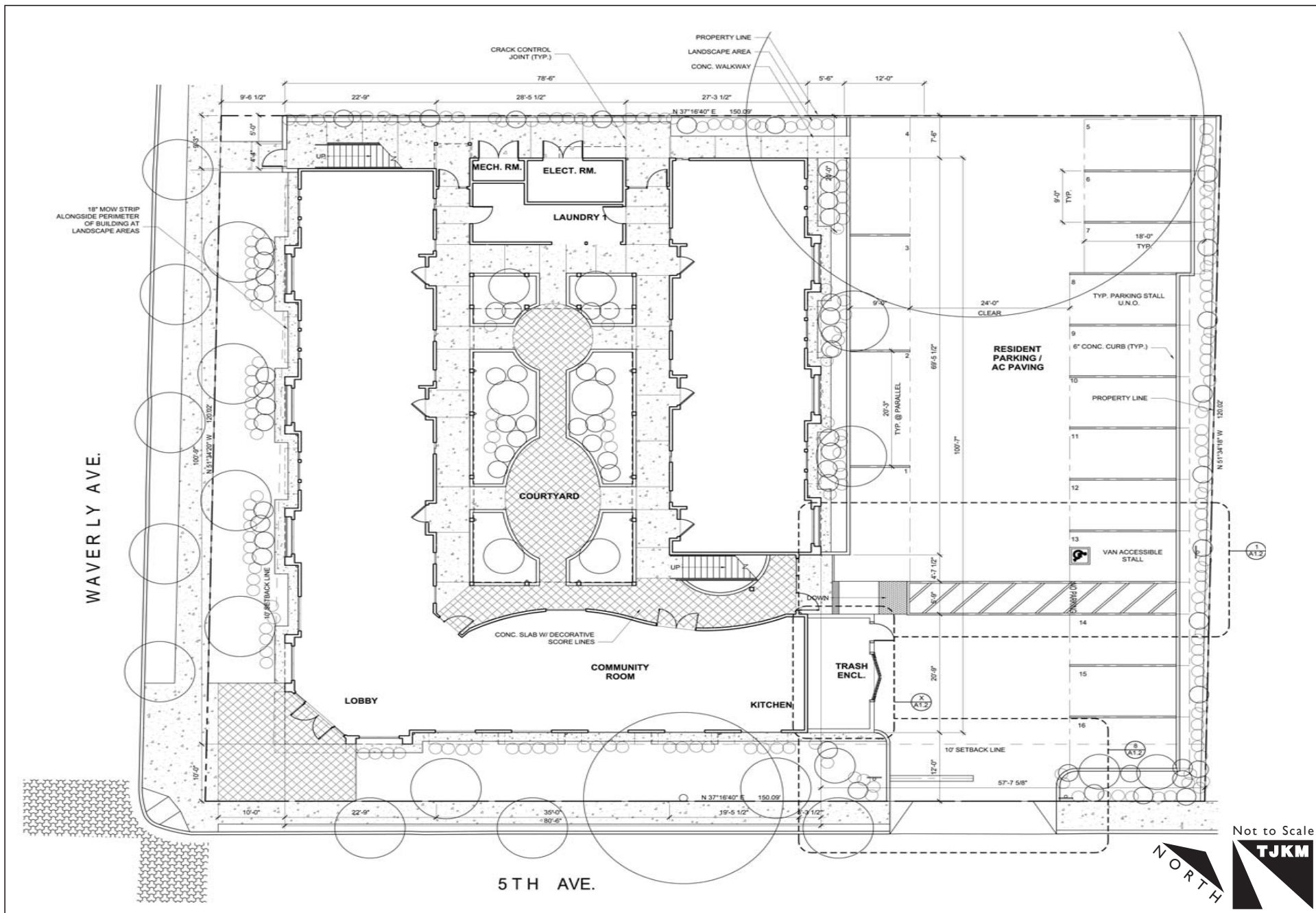

Intersection #1 Waverly Ave./Fifth Ave.	Intersection #2 El Camino Ave./Fifth Ave.	Intersection #3 Middlefield Rd./Fifth Ave.	

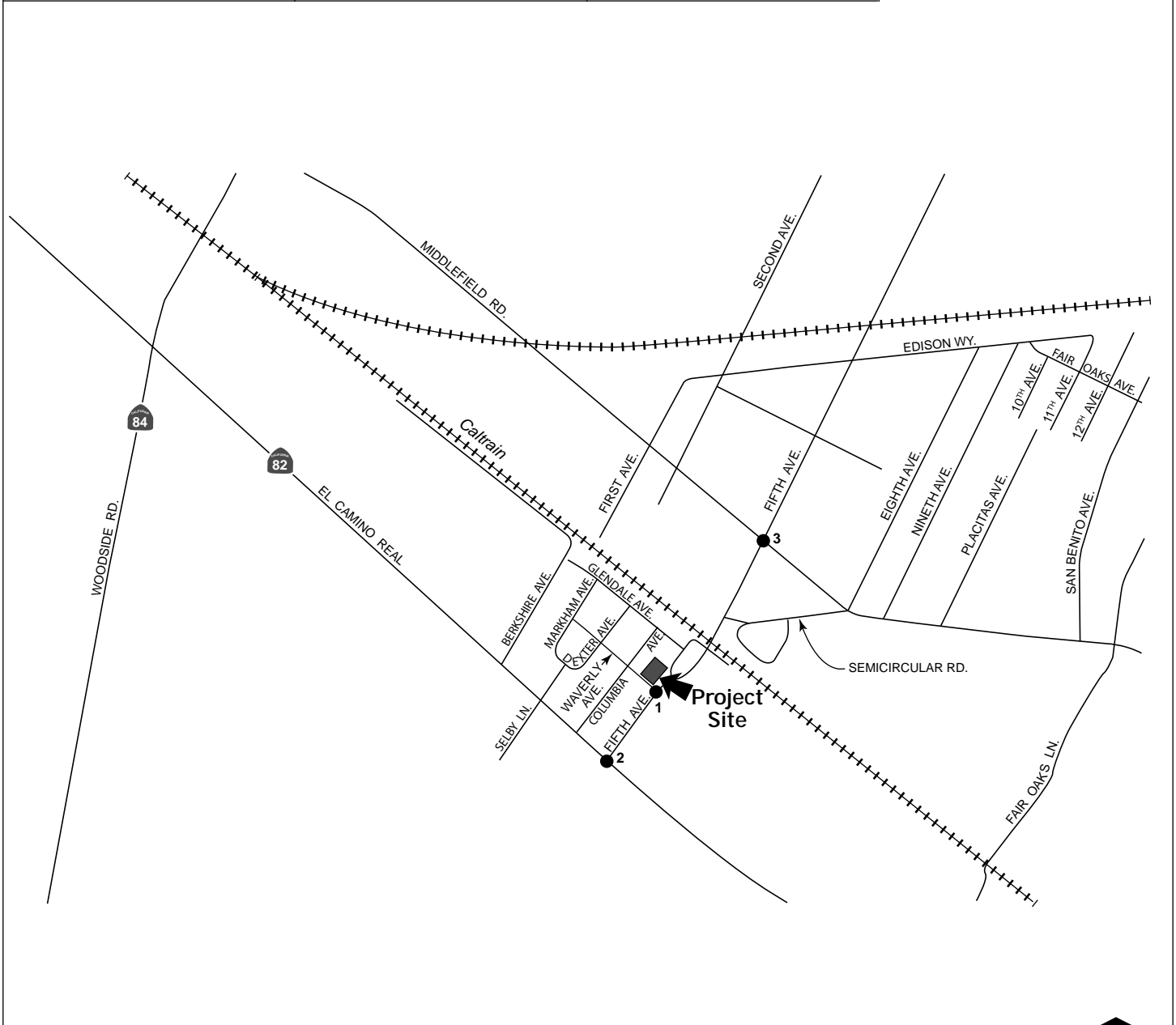

LEGEND	
	Existing Study Intersection
	Traffic Signal
XX	AM Peak Hour Volumes
(XX)	PM Peak Hour Volumes



Intersection #1 Waverly Ave./Fifth Ave.	Intersection #2 El Camino Ave./Fifth Ave.	Intersection #3 Middlefield Rd./Fifth Ave.	

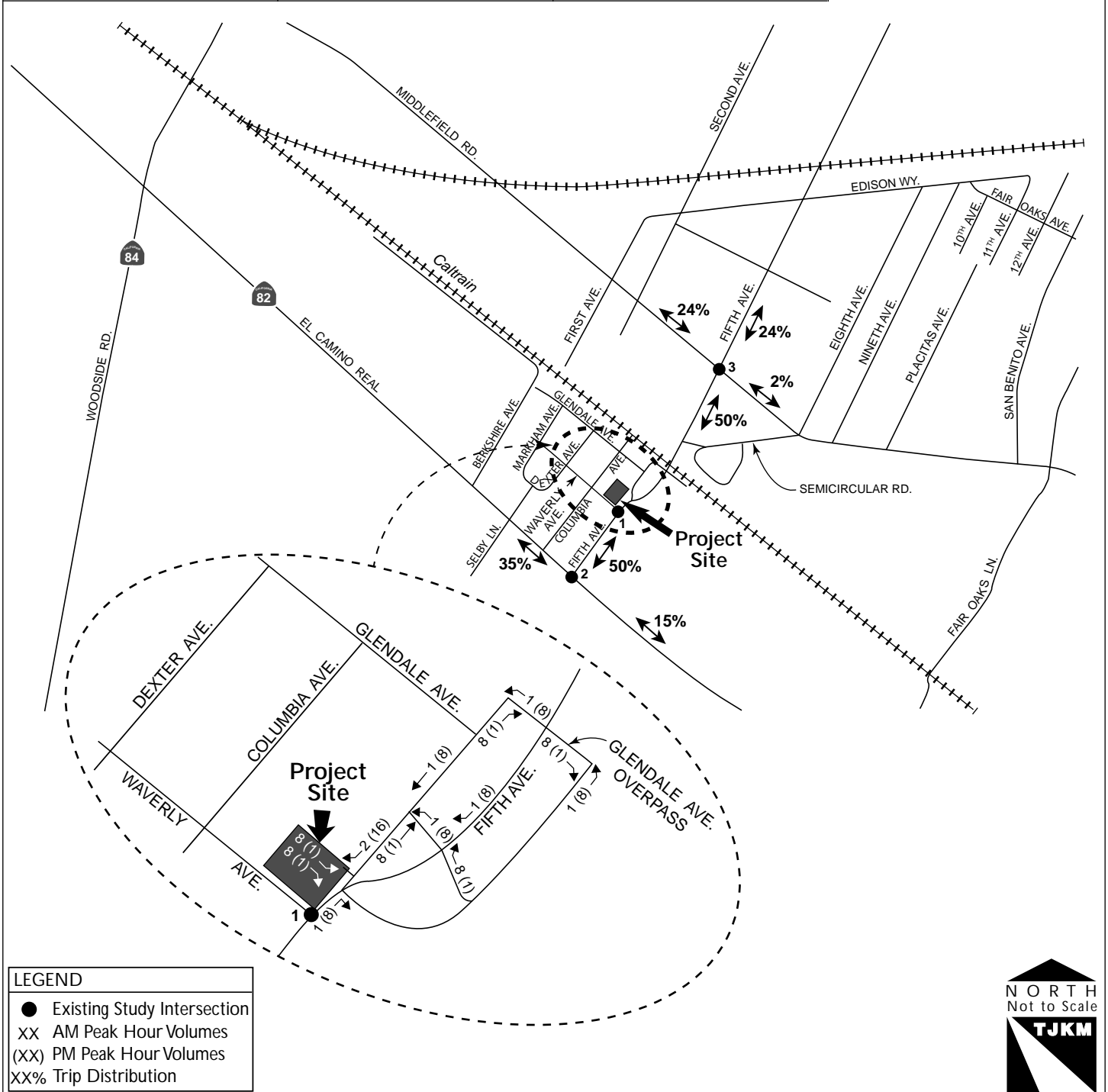

San Mateo County - TIS for Waverly Place Affordable Housing Development
 Existing plus Project Conditions Traffic Volumes, Lane Geometry, and Traffic Controls

Figure 5

Intersection #1 Waverly Ave./Fifth Ave.	Intersection #2 El Camino Ave./Fifth Ave.	Intersection #3 Middlefield Rd./Fifth Ave.	
<p>AM Peak Hour Volumes: 17 (18), 1,104 (896), 24 (26), 24 (16), 6 (12), 783 (661)</p> <p>PM Peak Hour Volumes: 17 (18), 1,104 (896), 24 (26), 24 (16), 6 (12), 783 (661)</p>	<p>AM Peak Hour Volumes: 609 (742), 431 (253), 221 (270), 748 (1,554)</p> <p>PM Peak Hour Volumes: 702 (550), 1,550 (971)</p>	<p>AM Peak Hour Volumes: 31 (40), 345 (308), 79 (46), 56 (53), 250 (396), 9 (13)</p> <p>PM Peak Hour Volumes: 25 (36), 426 (348), 357 (366), 164 (211), 227 (228), 27 (25)</p>	

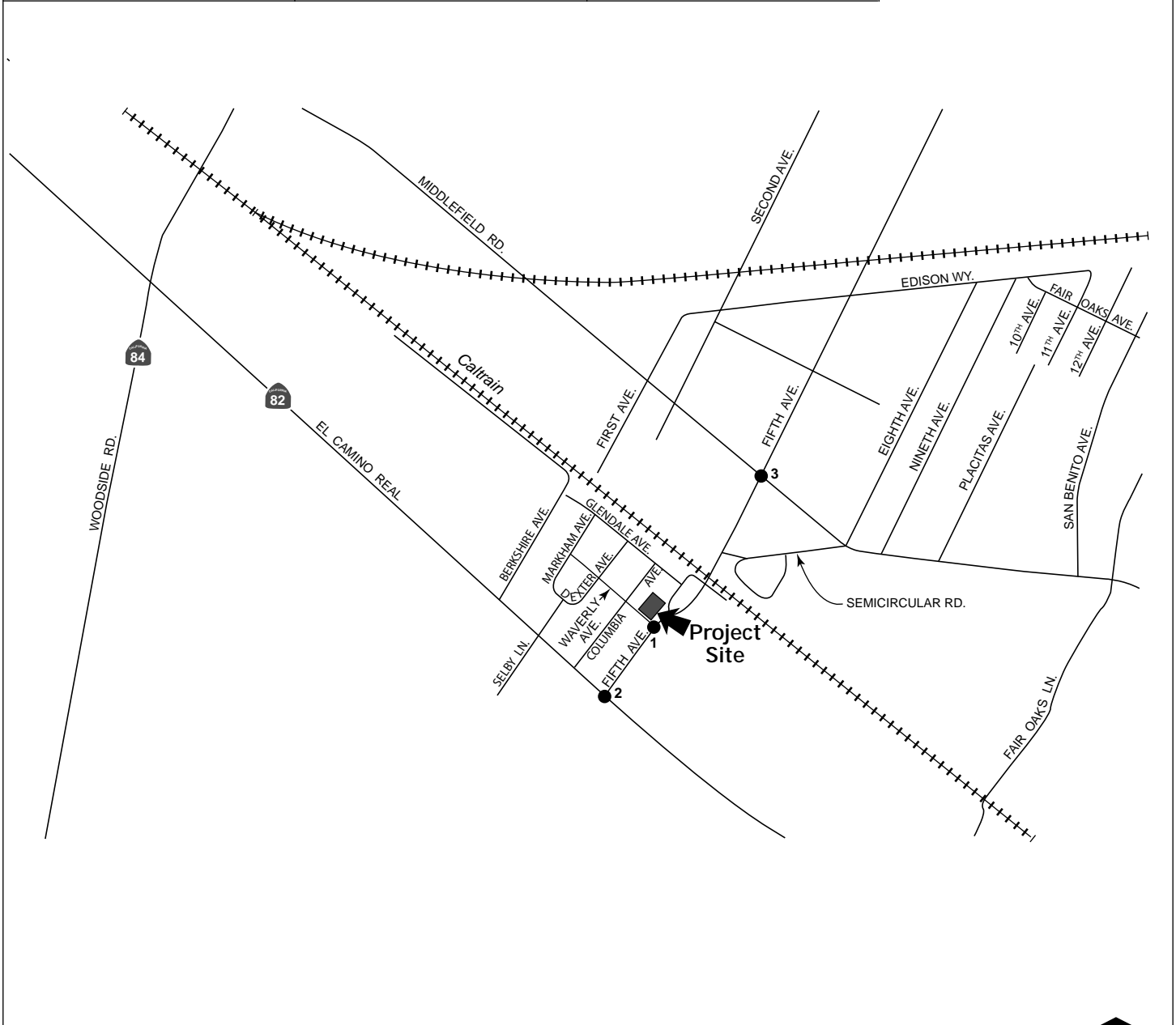

LEGEND	
	Existing Study Intersection
	Traffic Signal
XX	AM Peak Hour Volumes
(XX)	PM Peak Hour Volumes



APPENDIX A: Existing Turning Movement Counts

ALL TRAFFIC DATA

San Mateo County
 All Vehicles on Unshifted
 Peds & Bikes on Bank 1
 Nothing on Bank 2

(916) 771-8700

orders@atdtraffic.com

File Name : 14-7223-001 Waverly Avenue-Fifth Avenue.ppd
 Date : 4/8/2014

Unshifted Count = All Vehicles

START TIME	Waverly Avenue Southbound					Fifth Avenue Westbound					Northbound					Fifth Avenue Eastbound					Total	Uturn Total
	LEFT	THRU	RIGHT	UTURNS	APP.TOTAL	LEFT	THRU	RIGHT	UTURNS	APP.TOTAL	LEFT	THRU	RIGHT	UTURNS	APP.TOTAL	LEFT	THRU	RIGHT	UTURNS	APP.TOTAL		
07:00	5	0	4	0	9	0	149	1	0	150	0	0	0	0	0	0	103	0	0	103	262	0
07:15	7	0	4	0	11	0	210	3	0	213	0	0	0	0	0	1	116	0	0	117	341	0
07:30	10	0	7	0	17	0	282	8	0	290	0	0	0	0	0	3	156	0	0	159	466	0
07:45	6	0	8	0	14	0	299	5	0	304	0	0	0	0	0	1	210	0	0	211	529	0
Total	28	0	23	0	51	0	940	17	0	957	0	0	0	0	0	5	585	0	0	590	1598	0
08:00	0	0	5	0	5	0	287	2	0	289	0	0	0	0	0	0	227	0	0	227	521	0
08:15	8	0	4	0	12	0	228	2	0	230	0	0	0	0	0	2	199	0	0	201	443	0
08:30	8	0	6	0	14	0	173	1	0	174	0	0	0	0	0	3	178	0	0	181	369	0
08:45	2	0	6	0	8	0	154	2	0	156	0	0	0	0	0	4	157	0	0	161	325	0
Total	18	0	21	0	39	0	842	7	0	849	0	0	0	0	0	9	761	0	0	770	1658	0
16:00	5	0	3	0	8	0	210	4	0	214	0	0	0	0	0	2	217	0	0	219	441	0
16:15	7	0	3	0	10	0	206	2	0	208	0	0	0	0	0	2	217	0	0	219	437	0
16:30	6	0	3	0	9	0	244	9	0	253	0	0	0	0	0	4	193	0	0	197	459	0
16:45	5	0	5	0	10	0	203	4	0	207	0	0	0	0	0	2	207	0	0	209	426	0
Total	23	0	14	0	37	0	863	19	0	882	0	0	0	0	0	10	834	0	0	844	1763	0
17:00	8	0	5	0	13	0	242	3	0	245	0	0	0	0	0	4	236	0	0	240	498	0
17:15	6	0	7	0	13	0	238	3	0	241	0	0	0	0	0	4	167	0	0	171	425	0
17:30	6	0	4	0	10	0	251	2	0	253	0	0	0	0	0	1	166	0	0	167	430	0
17:45	5	0	3	0	8	0	201	1	0	202	0	0	0	0	0	2	170	0	0	172	382	0
Total	25	0	19	0	44	0	932	9	0	941	0	0	0	0	0	11	739	0	0	750	1735	0
Grand Total	94	0	77	0	171	0	3577	52	0	3629	0	0	0	0	0	35	2919	0	0	2954	6754	0
Apprch %	55.0%	0.0%	45.0%	0.0%		0.0%	98.6%	1.4%	0.0%		0.0%	0.0%	0.0%	0.0%		1.2%	98.8%	0.0%	0.0%			
Total %	1.4%	0.0%	1.1%	0.0%	2.5%	0.0%	53.0%	0.8%	0.0%	53.7%	0.0%	0.0%	0.0%	0.0%	0.0%	0.5%	43.2%	0.0%	0.0%	43.7%	100.0%	

AM PEAK HOUR	Waverly Avenue Southbound					Fifth Avenue Westbound					Northbound					Fifth Avenue Eastbound					Total	
	LEFT	THRU	RIGHT	UTURNS	APP.TOTAL	LEFT	THRU	RIGHT	UTURNS	APP.TOTAL	LEFT	THRU	RIGHT	UTURNS	APP.TOTAL	LEFT	THRU	RIGHT	UTURNS	APP.TOTAL		
07:30	10	0	7	0	17	0	282	8	0	290	0	0	0	0	0	3	156	0	0	159	466	
07:45	6	0	8	0	14	0	299	5	0	304	0	0	0	0	0	1	210	0	0	211	529	
08:00	0	0	5	0	5	0	287	2	0	289	0	0	0	0	0	0	227	0	0	227	521	
08:15	8	0	4	0	12	0	228	2	0	230	0	0	0	0	0	2	199	0	0	201	443	
Total Volume	24	0	24	0	48	0	1096	17	0	1113	0	0	0	0	0	6	792	0	0	798	1959	
% App Total	50.0%	0.0%	50.0%	0.0%		0.0%	98.5%	1.5%	0.0%		0.0%	0.0%	0.0%	0.0%		0.8%	99.2%	0.0%	0.0%			
PHF	.600	.000	.750	.000	.706	.000	.916	.531	.000	.915	.000	.000	.000	.000	.000	.500	.872	.000	.000	.879	.926	

PM PEAK HOUR	Waverly Avenue Southbound					Fifth Avenue Westbound					Northbound					Fifth Avenue Eastbound					Total	
	LEFT	THRU	RIGHT	UTURNS	APP.TOTAL	LEFT	THRU	RIGHT	UTURNS	APP.TOTAL	LEFT	THRU	RIGHT	UTURNS	APP.TOTAL	LEFT	THRU	RIGHT	UTURNS	APP.TOTAL		
16:15	7	0	3	0	10	0	206	2	0	208	0	0	0	0	0	2	217	0	0	219	437	
16:30	6	0	3	0	9	0	244	9	0	253	0	0	0	0	0	4	193	0	0	197	459	
16:45	5	0	5	0	10	0	203	4	0	207	0	0	0	0	0	2	207	0	0	209	426	
17:00	8	0	5	0	13	0	242	3	0	245	0	0	0	0	0	4	236	0	0	240	498	
Total Volume	26	0	16	0	42	0	895	18	0	913	0	0	0	0	0	12	853	0	0	865	1820	
% App Total	61.9%	0.0%	38.1%	0.0%		0.0%	98.0%	2.0%	0.0%		0.0%	0.0%	0.0%	0.0%		1.4%	98.6%	0.0%	0.0%			
PHF	.813	.000	.800	.000	.808	.000	.917	.500	.000	.902	.000	.000	.000	.000	.000	.750	.904	.000	.000	.901	.914	

ALL TRAFFIC DATA

San Mateo County
 All Vehicles on Unshifted
 Peds & Bikes on Bank 1
 Nothing on Bank 2

(916) 771-8700

orders@atdtraffic.com

File Name : 14-7223-001 Waverly Avenue-Fifth Avenue.ppd

Date : 4/8/2014

Bank 1 Count = Peds & Bikes

START TIME	Waverly Avenue Southbound					Fifth Avenue Westbound					Northbound					Fifth Avenue Eastbound					Total	Ped Total
	LEFT	THRU	RIGHT	PEDS	APP.TOTAL	LEFT	THRU	RIGHT	PEDS	APP.TOTAL	LEFT	THRU	RIGHT	PEDS	APP.TOTAL	LEFT	THRU	RIGHT	PEDS	APP.TOTAL		
07:00	1	0	1	1	2	0	2	0	0	2	0	0	0	0	0	1	1	0	0	2	6	1
07:15	1	0	1	1	2	0	0	0	7	0	0	0	0	0	0	0	3	0	0	3	5	8
07:30	0	0	0	3	0	0	1	0	8	1	0	0	0	0	0	0	0	0	0	0	1	11
07:45	0	0	1	3	1	0	1	0	8	1	0	0	0	0	0	0	3	0	0	3	5	11
Total	2	0	3	8	5	0	4	0	23	4	0	0	0	0	0	1	7	0	0	8	17	31
08:00	0	0	0	6	0	0	1	0	3	1	0	0	0	0	0	0	0	0	0	0	1	9
08:15	0	0	0	4	0	0	2	0	6	2	0	0	0	0	0	0	3	0	0	3	5	10
08:30	0	0	0	5	0	0	3	1	2	4	0	0	0	0	0	0	0	0	0	0	4	7
08:45	0	0	1	6	1	0	1	0	4	1	0	0	0	0	0	0	2	0	0	2	4	10
Total	0	0	1	21	1	0	7	1	15	8	0	0	0	0	0	0	5	0	0	5	14	36
16:00	1	0	0	4	1	0	2	0	1	2	0	0	0	0	0	0	0	0	0	0	3	5
16:15	0	0	1	3	1	0	1	1	3	2	0	0	0	0	0	0	2	0	0	2	5	6
16:30	0	0	1	4	1	0	2	0	3	2	0	0	0	0	0	0	4	0	0	4	7	7
16:45	0	0	1	8	1	0	3	2	4	5	0	0	0	0	0	0	1	0	0	1	7	12
Total	1	0	3	19	4	0	8	3	11	11	0	0	0	0	0	0	7	0	0	7	22	30
17:00	0	0	0	2	0	0	3	0	6	3	0	0	0	0	0	0	2	0	0	2	5	8
17:15	0	0	0	4	0	0	2	1	6	3	0	0	0	0	0	0	2	0	0	2	5	10
17:30	0	0	0	5	0	0	1	0	2	1	0	0	0	0	0	0	3	0	0	3	4	7
17:45	0	0	0	2	0	0	1	0	3	1	0	0	0	0	0	0	5	0	0	5	6	5
Total	0	0	0	13	0	0	7	1	17	8	0	0	0	0	0	0	12	0	0	12	20	30
Grand Total	3	0	7	61	10	0	26	5	66	31	0	0	0	0	0	1	31	0	0	32	73	127
Apprch %	30.0%	0.0%	70.0%			0.0%	83.9%	16.1%			0.0%	0.0%	0.0%			3.1%	96.9%	0.0%				
Total %	4.1%	0.0%	9.6%		13.7%	0.0%	35.6%	6.8%		42.5%	0.0%	0.0%	0.0%		0.0%	1.4%	42.5%	0.0%		43.8%	100.0%	

AM PEAK HOUR	Waverly Avenue Southbound					Fifth Avenue Westbound					Northbound					Fifth Avenue Eastbound					Total	
	LEFT	THRU	RIGHT	PEDS	APP.TOTAL	LEFT	THRU	RIGHT	PEDS	APP.TOTAL	LEFT	THRU	RIGHT	PEDS	APP.TOTAL	LEFT	THRU	RIGHT	PEDS	APP.TOTAL		
07:30	0	0	0	3	0	0	1	0	8	1	0	0	0	0	0	0	0	0	0	0	1	
07:45	0	0	1	3	1	0	1	0	8	1	0	0	0	0	0	0	3	0	0	3	5	
08:00	0	0	0	6	0	0	1	0	3	1	0	0	0	0	0	0	0	0	0	0	1	
08:15	0	0	0	4	0	0	2	0	6	2	0	0	0	0	0	0	3	0	0	3	5	
Total Volume	0	0	1	16	1	0	5	0	25	5	0	0	0	0	0	0	6	0	0	6	12	
% App Total	0.0%	0.0%	100.0%			0.0%	100.0%	0.0%			0.0%	0.0%	0.0%			0.0%	100.0%	0.0%				
PHF	.000	.000	.250		.250	.000	.625	.000		.625	.000	.000	.000		.000	.000	.500	.000		.500	.600	

PM PEAK HOUR	Waverly Avenue Southbound					Fifth Avenue Westbound					Northbound					Fifth Avenue Eastbound					Total	
	LEFT	THRU	RIGHT	PEDS	APP.TOTAL	LEFT	THRU	RIGHT	PEDS	APP.TOTAL	LEFT	THRU	RIGHT	PEDS	APP.TOTAL	LEFT	THRU	RIGHT	PEDS	APP.TOTAL		
16:15	0	0	1	3	1	0	1	1	3	2	0	0	0	0	0	0	2	0	0	2	5	
16:30	0	0	1	4	1	0	2	0	3	2	0	0	0	0	0	0	4	0	0	4	7	
16:45	0	0	1	8	1	0	3	2	4	5	0	0	0	0	0	0	1	0	0	1	7	
17:00	0	0	0	2	0	0	3	0	6	3	0	0	0	0	0	0	2	0	0	2	5	
Total Volume	0	0	3	17	3	0	9	3	16	12	0	0	0	0	0	0	9	0	0	9	24	
% App Total	0.0%	0.0%	100.0%			0.0%	75.0%	25.0%			0.0%	0.0%	0.0%			0.0%	100.0%	0.0%				
PHF	.000	.000	.750		.750	.000	.750	.375		.600	.000	.000	.000		.000	.000	.563	.000		.563	.857	

B.A.Y.M.E.T.R.I.C.S.

INTERSECTION TURNING MOVEMENT SUMMARY

PROJECT:	TRAFFIC COUNTS IN SAN MATEO COUNTY	SURVEY DATE:	3/5/2014	DAY:	WEDNESDAY
N-S APPROACH:	5TH AVENUE	SURVEY TIME:	7:00 AM	TO	9:00 AM
E-W APPROACH:	EL CAMINO REAL	JURISDICTION:	N. FAIR OAKS	FILE:	3403017-10AM

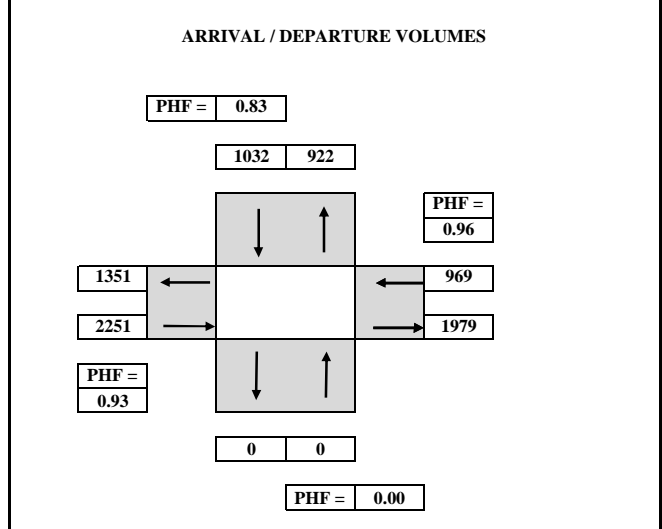
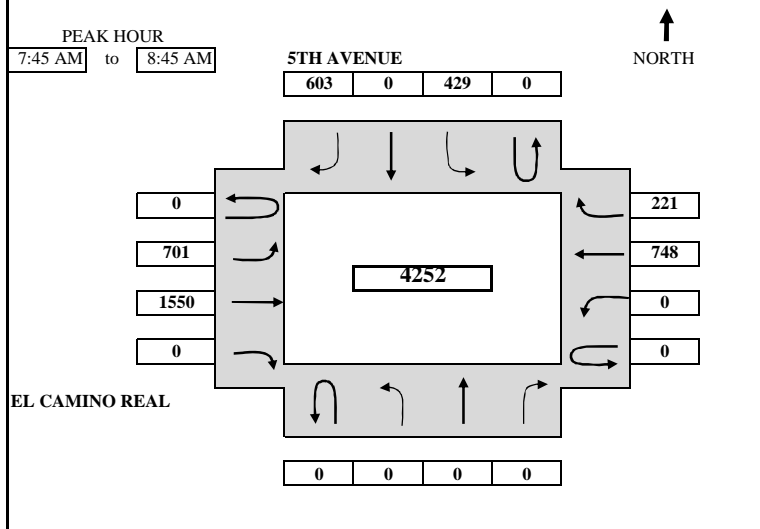

TIME PERIOD	NORTHBOUND				SOUTHBOUND				EASTBOUND				WESTBOUND				TOTAL
	U-TURN	LEFT	THRU	RIGHT	U-TURN	LEFT	THRU	RIGHT	U-TURN	LEFT	THRU	RIGHT	U-TURN	LEFT	THRU	RIGHT	

SURVEY DATA																			
7:00 AM to 7:15 AM					64	72				104	235				75 34				584
7:15 AM to 7:30 AM					128	159				220	597				159 66				1329
7:30 AM to 7:45 AM					246	331				349	1040				293 97				2356
7:45 AM to 8:00 AM					380	507				541	1413				469 167				3477
8:00 AM to 8:15 AM					490	705				701	1809				675 213				4593
8:15 AM to 8:30 AM					580	826				879	2155				870 265				5575
8:30 AM to 8:45 AM					675	934				1050	2590				1041 318				6608
8:45 AM to 9:00 AM					741	1018				1153	2961				1236 349				7458

TOTAL BY PERIOD																	
7:00 AM to 7:15 AM	0	0	0	0	0	64	0	72	0	104	235	0	0	0	75	34	584
7:15 AM to 7:30 AM	0	0	0	0	0	64	0	87	0	116	362	0	0	0	84	32	745
7:30 AM to 7:45 AM	0	0	0	0	0	118	0	172	0	129	443	0	0	0	134	31	1027
7:45 AM to 8:00 AM	0	0	0	0	0	134	0	176	0	192	373	0	0	0	176	70	1121
8:00 AM to 8:15 AM	0	0	0	0	0	110	0	198	0	160	396	0	0	0	206	46	1116
8:15 AM to 8:30 AM	0	0	0	0	0	90	0	121	0	178	346	0	0	0	195	52	982
8:30 AM to 8:45 AM	0	0	0	0	0	95	0	108	0	171	435	0	0	0	171	53	1033
8:45 AM to 9:00 AM	0	0	0	0	0	66	0	84	0	103	371	0	0	0	195	31	850

HOURLY TOTALS																	
7:00 AM to 8:00 AM	0	0	0	0	0	380	0	507	0	541	1413	0	0	0	469	167	3477
7:15 AM to 8:15 AM	0	0	0	0	0	426	0	633	0	597	1574	0	0	0	600	179	4009
7:30 AM to 8:30 AM	0	0	0	0	0	452	0	667	0	659	1558	0	0	0	711	199	4246
7:45 AM to 8:45 AM	0	0	0	0	0	429	0	603	0	701	1550	0	0	0	748	221	4252
8:00 AM to 9:00 AM	0	0	0	0	0	361	0	511	0	612	1548	0	0	0	767	182	3981

PEAK HOUR SUMMARY																	
7:45 AM to 8:45 AM	NORTHBOUND				SOUTHBOUND				EASTBOUND				WESTBOUND				TOTAL
	NBU	NBL	NBT	NBR	SBU	SBL	SBT	SBR	EBU	EBL	EBT	EBR	WBU	WBL	WBT	WBR	
VOLUME	0	0	0	0	0	429	0	603	0	701	1550	0	0	0	748	221	4252
PEDESTRIAN																	20
BICYCLE																	20
PHF BY MOVEMENT	0.00	0.00	0.00	0.00	0.00	0.80	0.00	0.76	0.00	0.91	0.89	0.00	0.00	0.00	0.91	0.79	OVERALL
PHF BY APPROACH	0.00				0.83				0.93				0.96				0.95

TEL: (510) 232 - 1271 FAX: (510) 232 - 1272

B.A.Y.M.E.T.R.I.C.S.

BICYCLE MOVEMENT SUMMARY

PROJECT: TRAFFIC COUNTS IN SAN MATEO COUNTY	SURVEY DATE: 3/5/2014	DAY: WEDNESDAY
N-S APPROACH: 5TH AVENUE	SURVEY TIME: 7:00 AM	TO 9:00 AM
E-W APPROACH: EL CAMINO REAL	JURISDICTION: N. FAIR OAKS	FILE: 3403017-10AM

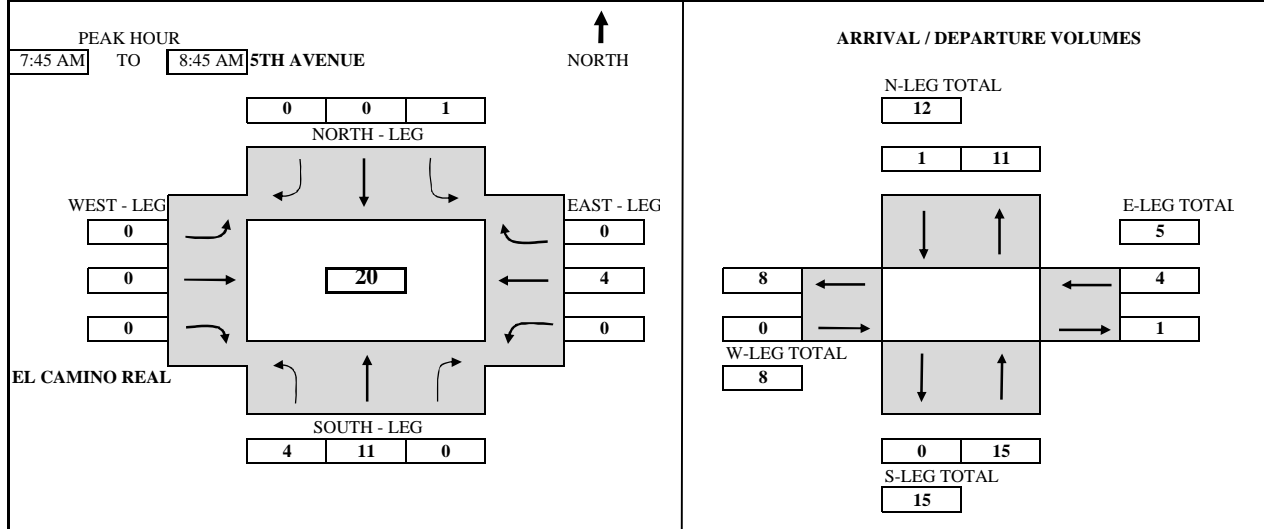

TIME	PERIOD	NB (SOUTH - LEG)			SB (NORTH - LEG)			EB (WEST - LEG)			WB (EAST - LEG)			TOTAL
		LEFT	THRU	RIGHT	LEFT	THRU	RIGHT	LEFT	THRU	RIGHT	LEFT	THRU	RIGHT	

SURVEY DATA														
7:00 AM	to	7:15 AM	0	0	0	0	0	0	0	0	0	0	0	0
7:15 AM	to	7:30 AM	1	6	0	0	0	0	0	0	0	0	0	7
7:30 AM	to	7:45 AM	1	11	0	1	0	0	0	0	0	0	0	13
7:45 AM	to	8:00 AM	1	14	0	1	0	0	0	0	0	0	1	17
8:00 AM	to	8:15 AM	1	16	0	1	0	0	0	0	0	0	3	21
8:15 AM	to	8:30 AM	3	19	0	2	0	0	0	0	0	4	0	28
8:30 AM	to	8:45 AM	5	22	0	2	0	0	0	0	0	4	0	33
8:45 AM	to	9:00 AM	7	24	0	2	0	0	0	0	0	4	0	37

TOTAL BY PERIOD														
7:00 AM	to	7:15 AM	0	0	0	0	0	0	0	0	0	0	0	0
7:15 AM	to	7:30 AM	1	6	0	0	0	0	0	0	0	0	0	7
7:30 AM	to	7:45 AM	0	5	0	1	0	0	0	0	0	0	0	6
7:45 AM	to	8:00 AM	0	3	0	0	0	0	0	0	0	1	0	4
8:00 AM	to	8:15 AM	0	2	0	0	0	0	0	0	0	2	0	4
8:15 AM	to	8:30 AM	2	3	0	1	0	0	0	0	0	1	0	7
8:30 AM	to	8:45 AM	2	3	0	0	0	0	0	0	0	0	0	5
8:45 AM	to	9:00 AM	2	2	0	0	0	0	0	0	0	0	0	4

HOURLY TOTALS														
7:00 AM	to	8:00 AM	1	14	0	1	0	0	0	0	0	1	0	17
7:15 AM	to	8:15 AM	1	16	0	1	0	0	0	0	0	3	0	21
7:30 AM	to	8:30 AM	2	13	0	2	0	0	0	0	0	4	0	21
7:45 AM	to	8:45 AM	4	11	0	1	0	0	0	0	0	4	0	20
8:00 AM	to	9:00 AM	6	10	0	1	0	0	0	0	0	3	0	20

TEL: (510) 232 - 1271 FAX: (510) 232 - 1272

7:45 AM	to	8:45 AM					
VOLUME BY APPROACH			NBT	SBT	EBT	WBT	TOTAL
BICYCLE			15	1	0	4	20

B.A.Y.M.E.T.R.I.C.S.

PEDESTRIAN MOVEMENT SUMMARY

PROJECT: TRAFFIC COUNTS IN SAN MATEO COUNTY	SURVEY DATE: 3/5/2014
N-S APPROACH: 5TH AVENUE	DAY: WEDNESDAY
E-W APPROACH: EL CAMINO REAL	JURISDICTION: N. FAIR OAKS
SURVEY PERIOD 7:00 AM TO 9:00 AM	FILE: 3403017-10AM

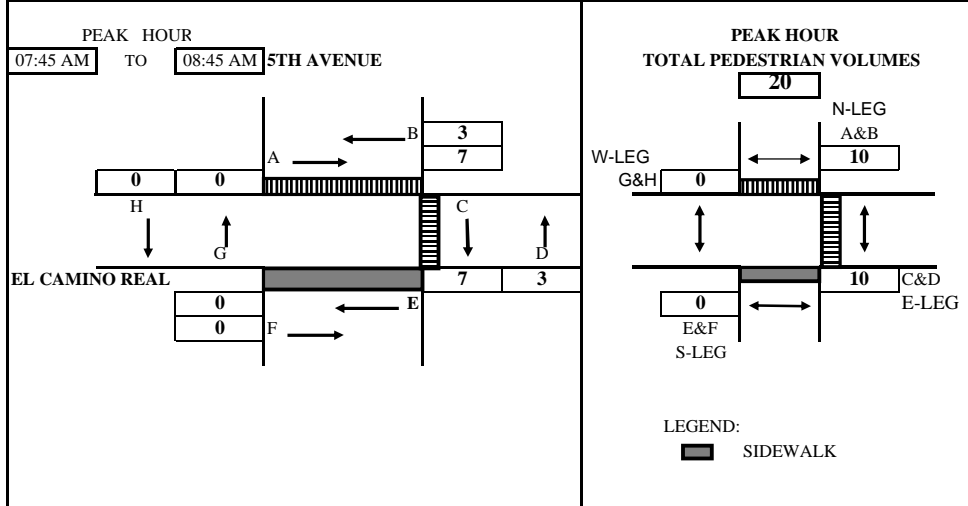

TIME PERIOD		NORTH X-WALK		EAST X-WALK		SOUTH X-WALK		WEST X-WALK		TOTAL
From	To	A	B	C	D	E	F	G	H	
SURVEY DATA										
07:00 AM	---	07:15 AM	1	0	0	0	0	0	0	1
07:15 AM	---	07:30 AM	5	1	1	1	0	0	0	8
07:30 AM	---	07:45 AM	9	1	4	3	0	0	0	17
07:45 AM	---	08:00 AM	13	1	8	3	0	0	0	25
08:00 AM	---	08:15 AM	14	3	8	3	0	0	0	28
08:15 AM	---	08:30 AM	15	3	10	6	0	0	0	34
08:30 AM	---	08:45 AM	16	4	11	6	0	0	0	37
08:45 AM	---	09:00 AM	18	4	12	8	0	0	0	42
TOTAL BY PERIOD										
07:00 AM	---	07:15 AM	1	0	0	0	0	0	0	1
07:15 AM	---	07:30 AM	4	1	1	1	0	0	0	7
07:30 AM	---	07:45 AM	4	0	3	2	0	0	0	9
07:45 AM	---	08:00 AM	4	0	4	0	0	0	0	8
08:00 AM	---	08:15 AM	1	2	0	0	0	0	0	3
08:15 AM	---	08:30 AM	1	0	2	3	0	0	0	6
08:30 AM	---	08:45 AM	1	1	1	0	0	0	0	3
08:45 AM	---	09:00 AM	2	0	1	2	0	0	0	5
HOURLY TOTALS										
07:00 AM	---	08:00 AM	13	1	8	3	0	0	0	25
07:15 AM	---	08:15 AM	13	3	8	3	0	0	0	27
07:30 AM	---	08:30 AM	10	2	9	5	0	0	0	26
07:45 AM	---	08:45 AM	7	3	7	3	0	0	0	20
08:00 AM	---	09:00 AM	5	3	4	5	0	0	0	17
<i>Tel : (510) 232-1271</i>			<i>Fax: (510) 232-1272</i>							

7:45 AM	to	8:45 AM					
VOLUME BY LEG			N-LEG	S-LEG	E-LEG	W-LEG	TOTAL
PEDESTRIAN			10	0	10	0	20

B.A.Y.M.E.T.R.I.C.S.

INTERSECTION TURNING MOVEMENT SUMMARY

PROJECT:	TRAFFIC COUNTS IN SAN MATEO COUNTY	SURVEY DATE:	4/24/2014	DAY:	THURSDAY
N-S APPROACH:	5TH AVENUE	SURVEY TIME:	4:00 PM	TO	6:00 PM
E-W APPROACH:	EL CAMINO REAL	JURISDICTION:	N. FAIR OAKS	FILE:	3404048-2PM

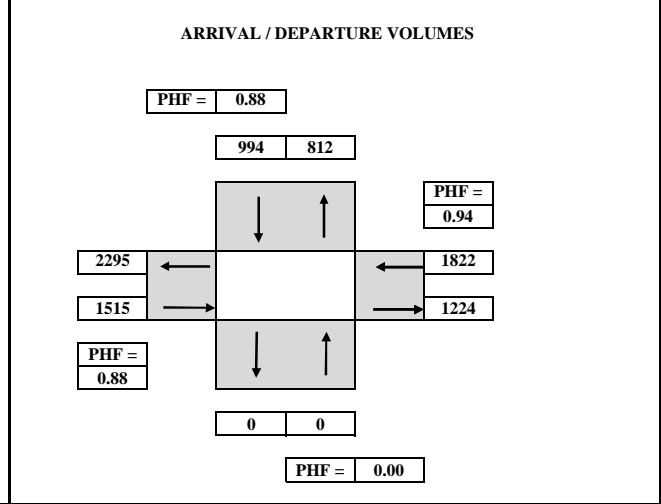
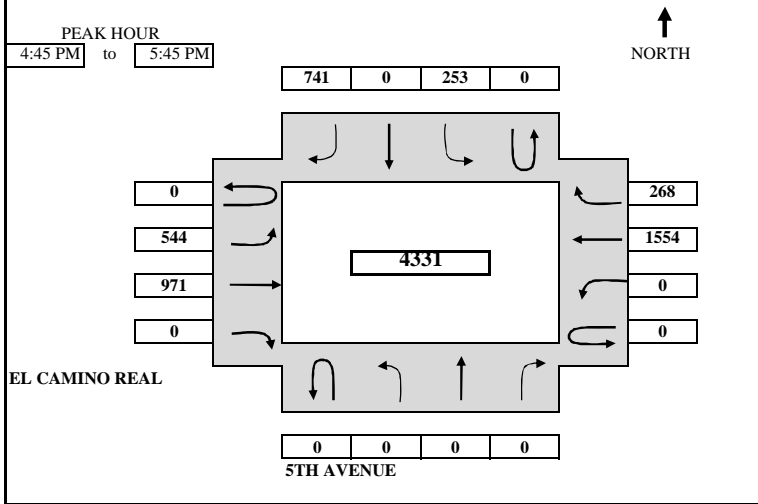

TIME PERIOD	NORTHBOUND				SOUTHBOUND				EASTBOUND				WESTBOUND				TOTAL
	U-TURN	LEFT	THRU	RIGHT	U-TURN	LEFT	THRU	RIGHT	U-TURN	LEFT	THRU	RIGHT	U-TURN	LEFT	THRU	RIGHT	

SURVEY DATA																		
4:00 PM to 4:15 PM					56				148					334			72	949
4:15 PM to 4:30 PM					106				300					728			148	1983
4:30 PM to 4:45 PM					164				459					1072			222	2953
4:45 PM to 5:00 PM					226				642					1456			305	4094
5:00 PM to 5:15 PM					286				830					1850			365	5139
5:15 PM to 5:30 PM					362				1036					2270			431	6302
5:30 PM to 5:45 PM					417				1200					2626			490	7284
5:45 PM to 6:00 PM					472				1381					3019			537	8300

TOTAL BY PERIOD																	
4:00 PM to 4:15 PM	0	0	0	0	0	56	0	148	0	120	219	0	0	0	334	72	949
4:15 PM to 4:30 PM	0	0	0	0	0	50	0	152	0	151	211	0	0	0	394	76	1034
4:30 PM to 4:45 PM	0	0	0	0	0	58	0	159	0	116	219	0	0	0	344	74	970
4:45 PM to 5:00 PM	0	0	0	0	0	62	0	183	0	163	266	0	0	0	384	83	1141
5:00 PM to 5:15 PM	0	0	0	0	0	60	0	188	0	141	202	0	0	0	394	60	1045
5:15 PM to 5:30 PM	0	0	0	0	0	76	0	206	0	129	266	0	0	0	420	66	1163
5:30 PM to 5:45 PM	0	0	0	0	0	55	0	164	0	111	237	0	0	0	356	59	982
5:45 PM to 6:00 PM	0	0	0	0	0	55	0	181	0	125	215	0	0	0	393	47	1016

HOURLY TOTALS																	
4:00 PM to 5:00 PM	0	0	0	0	0	226	0	642	0	550	915	0	0	0	1456	305	4094
4:15 PM to 5:15 PM	0	0	0	0	0	230	0	682	0	571	898	0	0	0	1516	293	4190
4:30 PM to 5:30 PM	0	0	0	0	0	256	0	736	0	549	953	0	0	0	1542	283	4319
4:45 PM to 5:45 PM	0	0	0	0	0	253	0	741	0	544	971	0	0	0	1554	268	4331
5:00 PM to 6:00 PM	0	0	0	0	0	246	0	739	0	506	920	0	0	0	1563	232	4206

PEAK HOUR SUMMARY																	
4:45 PM to 5:45 PM	NORTHBOUND				SOUTHBOUND				EASTBOUND				WESTBOUND				TOTAL
	NBU	NBL	NBT	NBR	SBU	SBL	SBT	SBR	EBU	EBL	EBT	EBR	WBU	WBL	WBT	WBR	
VOLUME	0	0	0	0	0	253	0	741	0	544	971	0	0	0	1554	268	4331
PEDESTRIAN																	13
BICYCLE																	15
PHF BY MOVEMENT	0.00	0.00	0.00	0.00	0.00	0.83	0.00	0.90	0.00	0.83	0.91	0.00	0.00	0.00	0.93	0.81	OVERALL
PHF BY APPROACH	0.00				0.88				0.88				0.94				0.93

TEL: (510) 232 - 1271 FAX: (510) 232 - 1272

B.A.Y.M.E.T.R.I.C.S.

BICYCLE MOVEMENT SUMMARY

PROJECT: TRAFFIC COUNTS IN SAN MATEO COUNTY	SURVEY DATE: 4/24/2014	DAY: THURSDAY
N-S APPROACH: 5TH AVENUE	SURVEY TIME: 4:00 PM	TO: 6:00 PM
E-W APPROACH: EL CAMINO REAL	JURISDICTION: N. FAIR OAKS	FILE: 3404048-2PM

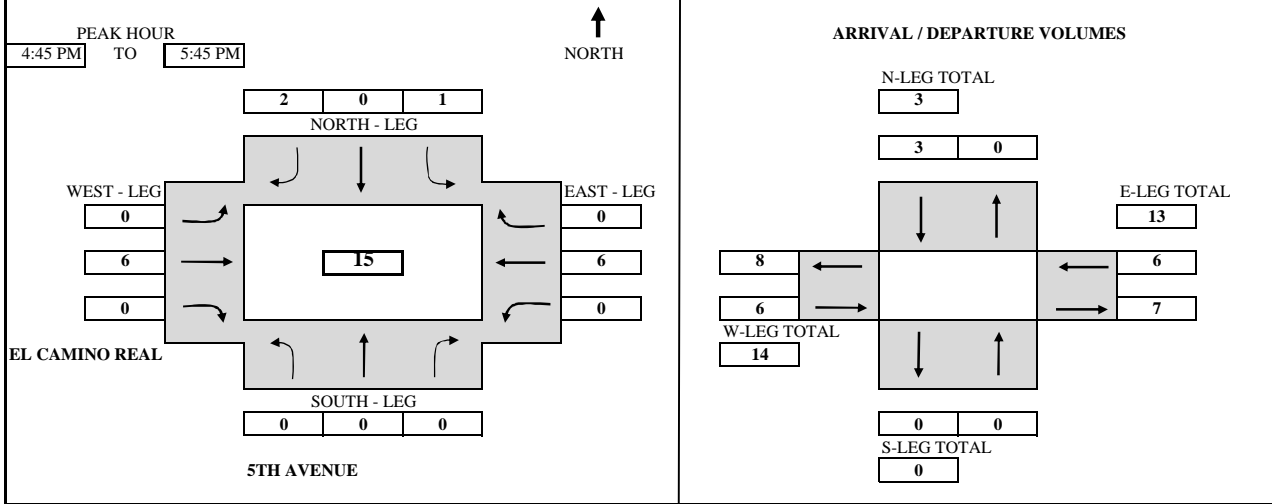

TIME PERIOD		NB (SOUTH - LEG)			SB (NORTH - LEG)			EB (WEST - LEG)			WB (EAST - LEG)			TOTAL
From	To	LEFT	THRU	RIGHT	LEFT	THRU	RIGHT	LEFT	THRU	RIGHT	LEFT	THRU	RIGHT	
SURVEY DATA														
4:00 PM	to 4:15 PM	0	0	0	0	0	0	0	2	0	0	1	0	3
4:15 PM	to 4:30 PM	0	0	0	0	0	0	0	3	0	0	4	1	8
4:30 PM	to 4:45 PM	0	0	0	0	0	0	0	3	0	0	5	1	9
4:45 PM	to 5:00 PM	0	0	0	0	0	0	0	6	0	0	7	1	14
5:00 PM	to 5:15 PM	0	0	0	0	0	0	0	8	0	0	8	1	17
5:15 PM	to 5:30 PM	0	0	0	0	0	0	0	8	0	0	9	1	18
5:30 PM	to 5:45 PM	0	0	0	1	0	2	0	9	0	0	11	1	24
5:45 PM	to 6:00 PM	0	0	0	1	0	3	0	10	0	0	12	1	27
TOTAL BY PERIOD														
4:00 PM	to 4:15 PM	0	0	0	0	0	0	0	2	0	0	1	0	3
4:15 PM	to 4:30 PM	0	0	0	0	0	0	0	1	0	0	3	1	5
4:30 PM	to 4:45 PM	0	0	0	0	0	0	0	0	0	0	1	0	1
4:45 PM	to 5:00 PM	0	0	0	0	0	0	0	3	0	0	2	0	5
5:00 PM	to 5:15 PM	0	0	0	0	0	0	0	2	0	0	1	0	3
5:15 PM	to 5:30 PM	0	0	0	0	0	0	0	0	0	0	1	0	1
5:30 PM	to 5:45 PM	0	0	0	1	0	2	0	1	0	0	2	0	6
5:45 PM	to 6:00 PM	0	0	0	0	0	1	0	1	0	0	1	0	3
HOURLY TOTALS														
4:00 PM	to 5:00 PM	0	0	0	0	0	0	0	6	0	0	7	1	14
4:15 PM	to 5:15 PM	0	0	0	0	0	0	0	6	0	0	7	1	14
4:30 PM	to 5:30 PM	0	0	0	0	0	0	0	5	0	0	5	0	10
4:45 PM	to 5:45 PM	0	0	0	1	0	2	0	6	0	0	6	0	15
5:00 PM	to 6:00 PM	0	0	0	1	0	3	0	4	0	0	5	0	13

TEL: (510) 232 - 1271 FAX: (510) 232 - 1272

4:45 PM	to	5:45 PM					
VOLUME BY APPROACH	NBT	SBT	EBT	WBT	TOTAL		
BICYCLE	0	3	6	6	15		

B.A.Y.M.E.T.R.I.C.S.

PEDESTRIAN MOVEMENT SUMMARY

PROJECT: TRAFFIC COUNTS IN SAN MATEO COUNTY	SURVEY DATE: 4/24/2014
N-S APPROACH: 5TH AVENUE	DAY: THURSDAY
E-W APPROACH: EL CAMINO REAL	JURISDICTION: N. FAIR OAKS
SURVEY PERIOD: 4:00 PM TO 6:00 PM	FILE: 3404048-2PM

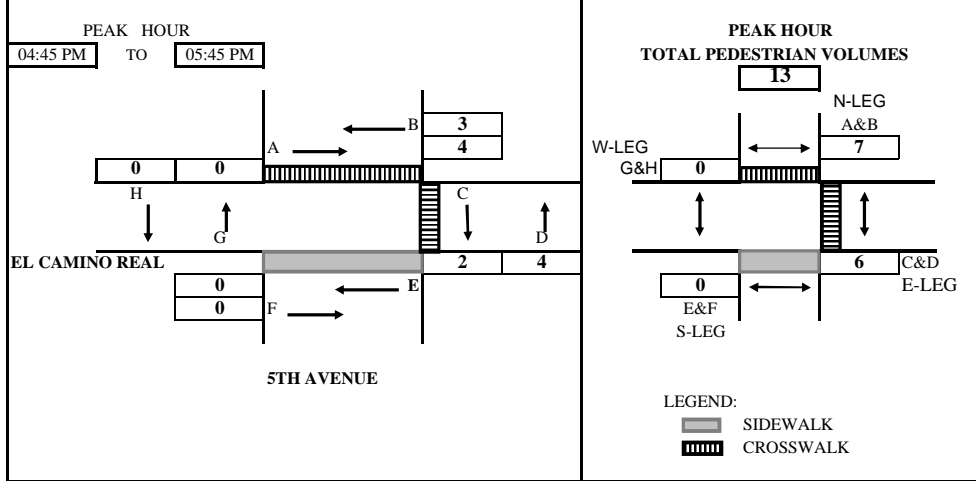

TIME PERIOD		NORTH X-WALK		EAST X-WALK		SOUTH X-WALK		WEST X-WALK		TOTAL
From	To	A	B	C	D	E	F	G	H	
SURVEY DATA										
04:00 PM	--- 04:15 PM	0	3	1	2	0	0	0	0	6
04:15 PM	--- 04:30 PM	0	3	1	2	0	0	0	0	6
04:30 PM	--- 04:45 PM	0	3	3	4	0	0	0	0	10
04:45 PM	--- 05:00 PM	0	4	4	4	0	0	0	0	12
05:00 PM	--- 05:15 PM	1	5	5	4	0	0	0	0	15
05:15 PM	--- 05:30 PM	2	5	5	7	0	0	0	0	19
05:30 PM	--- 05:45 PM	4	6	5	8	0	0	0	0	23
05:45 PM	--- 06:00 PM	7	6	6	8	0	0	0	0	27
TOTAL BY PERIOD										
04:00 PM	--- 04:15 PM	0	3	1	2	0	0	0	0	6
04:15 PM	--- 04:30 PM	0	0	0	0	0	0	0	0	0
04:30 PM	--- 04:45 PM	0	0	2	2	0	0	0	0	4
04:45 PM	--- 05:00 PM	0	1	1	0	0	0	0	0	2
05:00 PM	--- 05:15 PM	1	1	1	0	0	0	0	0	3
05:15 PM	--- 05:30 PM	1	0	0	3	0	0	0	0	4
05:30 PM	--- 05:45 PM	2	1	0	1	0	0	0	0	4
05:45 PM	--- 06:00 PM	3	0	1	0	0	0	0	0	4
HOURLY TOTALS										
04:00 PM	--- 05:00 PM	0	4	4	4	0	0	0	0	12
04:15 PM	--- 05:15 PM	1	2	4	2	0	0	0	0	9
04:30 PM	--- 05:30 PM	2	2	4	5	0	0	0	0	13
04:45 PM	--- 05:45 PM	4	3	2	4	0	0	0	0	13
05:00 PM	--- 06:00 PM	7	2	2	4	0	0	0	0	15

Tel : (510) 232-1271

Fax: (510) 232-1272

4:45 PM	to	5:45 PM					
VOLUME BY LEG			N-LEG	S-LEG	E-LEG	W-LEG	TOTAL
PEDESTRIAN			7	0	6	0	13

B.A.Y.M.E.T.R.I.C.S.

INTERSECTION TURNING MOVEMENT SUMMARY

PROJECT:	TRAFFIC COUNTS IN SAN MATEO COUNTY	SURVEY DATE:	3/6/2014	DAY:	THURSDAY
N-S APPROACH:	5TH AVENUE	SURVEY TIME:	7:00 AM	TO	9:00 AM
E-W APPROACH:	MIDDLEFIELD ROAD	JURISDICTION:	N. FAIR OAKS	FILE:	3403017-6AM

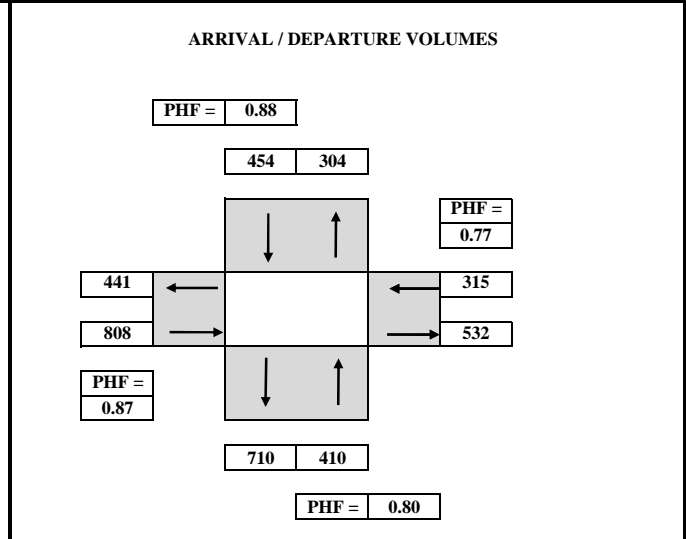
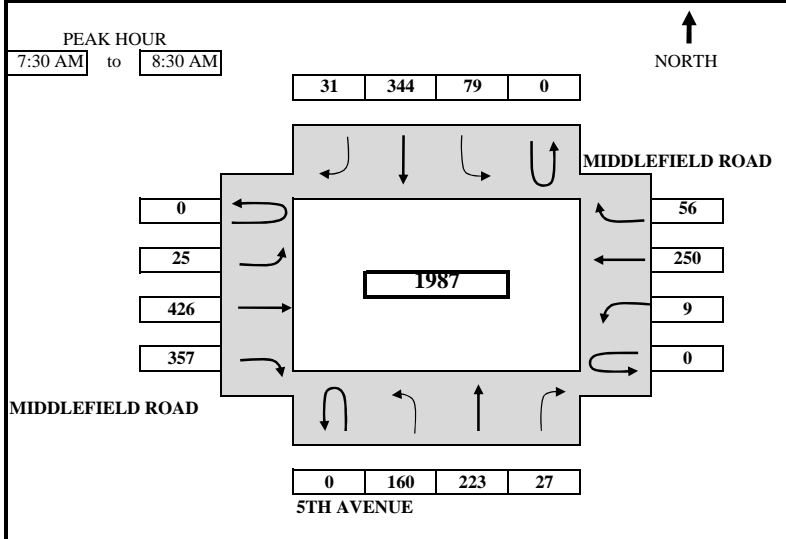

TIME PERIOD	NORTHBOUND				SOUTHBOUND				EASTBOUND				WESTBOUND				TOTAL
	From	To	U-TURN	LEFT	THRU	RIGHT	U-TURN	LEFT	THRU	RIGHT	U-TURN	LEFT	THRU	RIGHT	U-TURN	LEFT	

SURVEY DATA																		
7:00 AM to 7:15 AM	22	32	8	17	62	6	6	47	44	3	36	5	288					
7:15 AM to 7:30 AM	46	72	10	36	123	16	11	113	117	4	83	18	649					
7:30 AM to 7:45 AM	71	97	13	60	223	21	19	228	226	8	122	27	1115					
7:45 AM to 8:00 AM	115	151	23	76	307	31	25	344	329	10	186	40	1637					
8:00 AM to 8:15 AM	162	226	29	102	382	40	30	456	420	11	272	55	2185					
8:15 AM to 8:30 AM	206	295	37	115	467	47	36	539	474	13	333	74	2636					
8:30 AM to 8:45 AM	260	362	44	128	546	62	39	610	527	16	389	86	3069					
8:45 AM to 9:00 AM	289	410	48	147	611	71	48	689	584	21	454	92	3464					

TOTAL BY PERIOD																		
7:00 AM to 7:15 AM	0	22	32	8	0	17	62	6	0	6	47	44	0	3	36	5	288	
7:15 AM to 7:30 AM	0	24	40	2	0	19	61	10	0	5	66	73	0	1	47	13	361	
7:30 AM to 7:45 AM	0	25	25	3	0	24	100	5	0	8	115	109	0	4	39	9	466	
7:45 AM to 8:00 AM	0	44	54	10	0	16	84	10	0	6	116	103	0	2	64	13	522	
8:00 AM to 8:15 AM	0	47	75	6	0	26	75	9	0	5	112	91	0	1	86	15	548	
8:15 AM to 8:30 AM	0	44	69	8	0	13	85	7	0	6	83	54	0	2	61	19	451	
8:30 AM to 8:45 AM	0	54	67	7	0	13	79	15	0	3	71	53	0	3	56	12	433	
8:45 AM to 9:00 AM	0	29	48	4	0	19	65	9	0	9	79	57	0	5	65	6	395	

HOURLY TOTALS																		
7:00 AM to 8:00 AM	0	115	151	23	0	76	307	31	0	25	344	329	0	10	186	40	1637	
7:15 AM to 8:15 AM	0	140	194	21	0	85	320	34	0	24	409	376	0	8	236	50	1897	
7:30 AM to 8:30 AM	0	160	223	27	0	79	344	31	0	25	426	357	0	9	250	56	1987	
7:45 AM to 8:45 AM	0	189	265	31	0	68	323	41	0	20	382	301	0	8	267	59	1954	
8:00 AM to 9:00 AM	0	174	259	25	0	71	304	40	0	23	345	255	0	11	268	52	1827	

PEAK HOUR SUMMARY																		
7:30 AM to 8:30 AM	NORTHBOUND				SOUTHBOUND				EASTBOUND				WESTBOUND				TOTAL	
	NBU	NBL	NBT	NBR	SBU	SBL	SBT	SBR	EBU	EBL	EBT	EBR	WBU	WBL	WBT	WBR		
VOLUME	0	160	223	27	0	79	344	31	0	25	426	357	0	9	250	56	1987	
PEDESTRIAN																	104	
BICYCLE																	14	
PHF BY MOVEMENT	0.00	0.85	0.74	0.68	0.00	0.76	0.86	0.78	0.00	0.78	0.92	0.82	0.00	0.56	0.73	0.74	OVERALL	
PHF BY APPROACH	0.80				0.88				0.87				0.77				0.91	

TEL: (510) 232 - 1271

FAX: (510) 232 - 1272

B.A.Y.M.E.T.R.I.C.S.

BICYCLE MOVEMENT SUMMARY

PROJECT: TRAFFIC COUNTS IN SAN MATEO COUNTY SURVEY DATE: 3/6/2014 DAY: THURSDAY
 N-S APPROACH: 5TH AVENUE SURVEY TIME: 7:00 AM TO 9:00 AM
 E-W APPROACH: MIDDLEFIELD ROAD JURISDICTION: N. FAIR OAKS FILE: 3403017-6AM

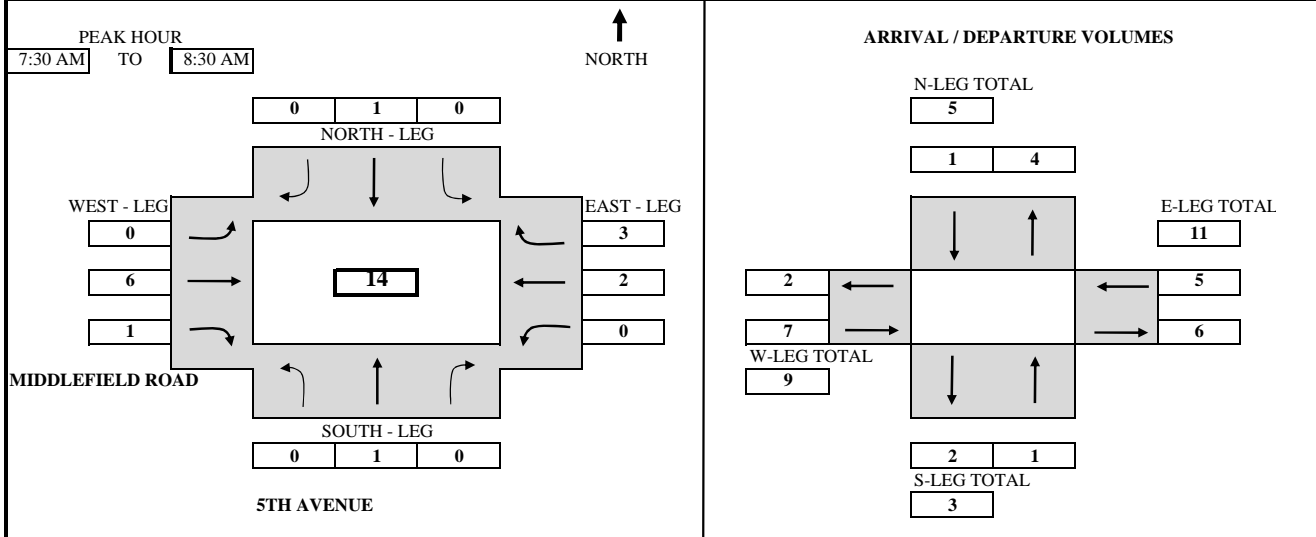

TIME PERIOD	NB (SOUTH - LEG)			SB (NORTH - LEG)			EB (WEST - LEG)			WB (EAST - LEG)			TOTAL
From To	LEFT	THRU	RIGHT	LEFT	THRU	RIGHT	LEFT	THRU	RIGHT	LEFT	THRU	RIGHT	

SURVEY DATA															
7:00 AM	to	7:15 AM	0	0	1	0	0	0	0	0	0	0	1	1	3
7:15 AM	to	7:30 AM	0	0	1	0	0	0	0	1	1	0	3	1	7
7:30 AM	to	7:45 AM	0	0	1	0	0	0	0	1	2	0	3	1	8
7:45 AM	to	8:00 AM	0	1	1	0	1	0	0	4	2	0	4	2	15
8:00 AM	to	8:15 AM	0	1	1	0	1	0	0	5	2	0	4	2	16
8:15 AM	to	8:30 AM	0	1	1	0	1	0	0	7	2	0	5	4	21
8:30 AM	to	8:45 AM	0	1	1	0	1	0	0	10	2	0	8	4	27
8:45 AM	to	9:00 AM	1	2	1	0	1	0	0	11	2	0	8	4	30

TOTAL BY PERIOD															
7:00 AM	to	7:15 AM	0	0	1	0	0	0	0	0	0	0	1	1	3
7:15 AM	to	7:30 AM	0	0	0	0	0	0	0	1	1	0	2	0	4
7:30 AM	to	7:45 AM	0	0	0	0	0	0	0	0	1	0	0	0	1
7:45 AM	to	8:00 AM	0	1	0	0	1	0	0	3	0	0	1	1	7
8:00 AM	to	8:15 AM	0	0	0	0	0	0	0	1	0	0	0	0	1
8:15 AM	to	8:30 AM	0	0	0	0	0	0	0	2	0	0	1	2	5
8:30 AM	to	8:45 AM	0	0	0	0	0	0	0	3	0	0	3	0	6
8:45 AM	to	9:00 AM	1	1	0	0	0	0	0	1	0	0	0	0	3

HOURLY TOTALS															
7:00 AM	to	8:00 AM	0	1	1	0	1	0	0	4	2	0	4	2	15
7:15 AM	to	8:15 AM	0	1	0	0	1	0	0	5	2	0	3	1	13
7:30 AM	to	8:30 AM	0	1	0	0	1	0	0	6	1	0	2	3	14
7:45 AM	to	8:45 AM	0	1	0	0	1	0	0	9	0	0	5	3	19
8:00 AM	to	9:00 AM	1	1	0	0	0	0	0	7	0	0	4	2	15

TEL: (510) 232 - 1271 FAX: (510) 232 - 1272

7:30 AM to 8:30 AM					
VOLUME BY APPROACH	NBT	SBT	EBT	WBT	TOTAL
BICYCLE	1	1	7	5	14

B. A. Y. M. E. T. R. I. C. S.

PEDESTRIAN MOVEMENT SUMMARY

PROJECT: TRAFFIC COUNTS IN SAN MATEO COUNTY	SURVEY DATE: 3/6/2014
N-S APPROACH: 5TH AVENUE	DAY: THURSDAY
E-W APPROACH: MIDDLEFIELD ROAD	JURISDICTION: N. FAIR OAKS
SURVEY PERIOD: 7:00 AM TO 9:00 AM	FILE: 3403017-6AM

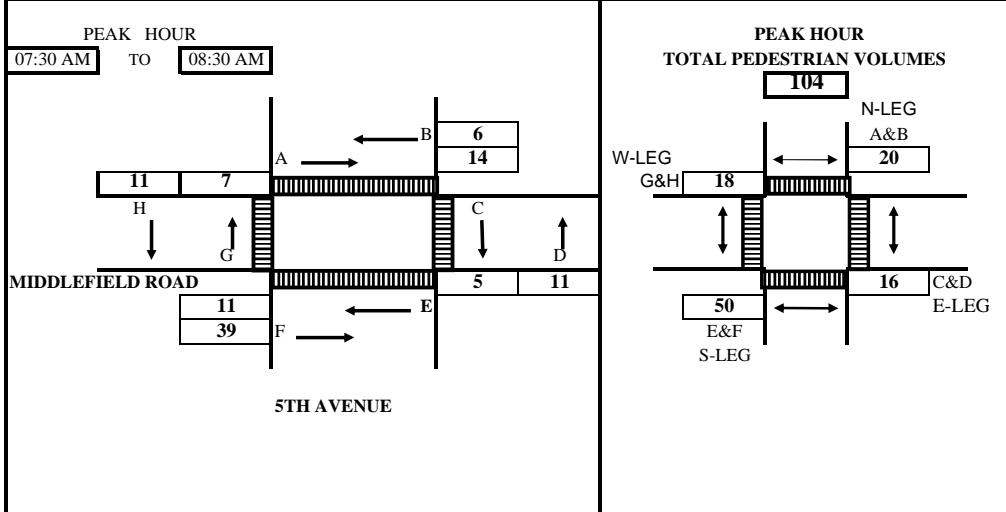

TIME PERIOD		NORTH X-WALK		EAST X-WALK		SOUTH X-WALK		WEST X-WALK		TOTAL
From	To	A	B	C	D	E	F	G	H	

SURVEY DATA											
07:00 AM	---	07:15 AM	3	3	3	1	1	6	0	0	17
07:15 AM	---	07:30 AM	5	11	3	3	1	8	1	2	34
07:30 AM	---	07:45 AM	8	13	3	9	3	18	5	7	66
07:45 AM	---	08:00 AM	13	13	5	12	3	36	6	7	95
08:00 AM	---	08:15 AM	14	13	5	12	6	46	7	11	114
08:15 AM	---	08:30 AM	19	17	8	14	12	47	8	13	138
08:30 AM	---	08:45 AM	21	19	9	15	15	51	11	15	156
08:45 AM	---	09:00 AM	26	21	11	17	15	55	12	17	174

TOTAL BY PERIOD											
07:00 AM	---	07:15 AM	3	3	3	1	1	6	0	0	17
07:15 AM	---	07:30 AM	2	8	0	2	0	2	1	2	17
07:30 AM	---	07:45 AM	3	2	0	6	2	10	4	5	32
07:45 AM	---	08:00 AM	5	0	2	3	0	18	1	0	29
08:00 AM	---	08:15 AM	1	0	0	0	3	10	1	4	19
08:15 AM	---	08:30 AM	5	4	3	2	6	1	1	2	24
08:30 AM	---	08:45 AM	2	2	1	1	3	4	3	2	18
08:45 AM	---	09:00 AM	5	2	2	2	0	4	1	2	18

HOURLY TOTALS											
07:00 AM	---	08:00 AM	13	13	5	12	3	36	6	7	95
07:15 AM	---	08:15 AM	11	10	2	11	5	40	7	11	97
07:30 AM	---	08:30 AM	14	6	5	11	11	39	7	11	104
07:45 AM	---	08:45 AM	13	6	6	6	12	33	6	8	90
08:00 AM	---	09:00 AM	13	8	6	5	12	19	6	10	79

Tel : (510) 232-1271

Fax: (510) 232-1272

7:30 AM	to	8:30 AM					
VOLUME BY LEG			N-LEG	S-LEG	E-LEG	W-LEG	TOTAL
PEDESTRIAN			20	50	16	18	104

B.A.Y.M.E.T.R.I.C.S.

INTERSECTION TURNING MOVEMENT SUMMARY

PROJECT:	TRAFFIC COUNTS IN SAN MATEO COUNTY	SURVEY DATE:	4/24/2014	DAY:	THURSDAY
N-S APPROACH:	5TH AVENUE	SURVEY TIME:	4:00 PM	TO	6:00 PM
E-W APPROACH:	MIDDLEFIELD ROAD	JURISDICTION:	N. FAIR OAKS	FILE:	3404048-1PM

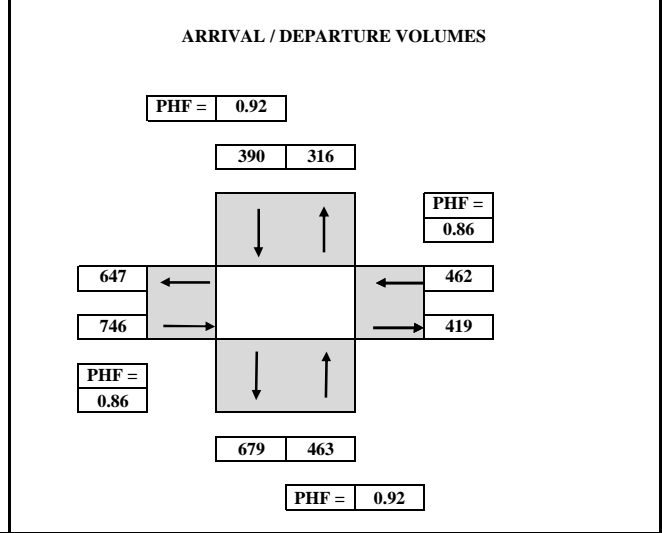
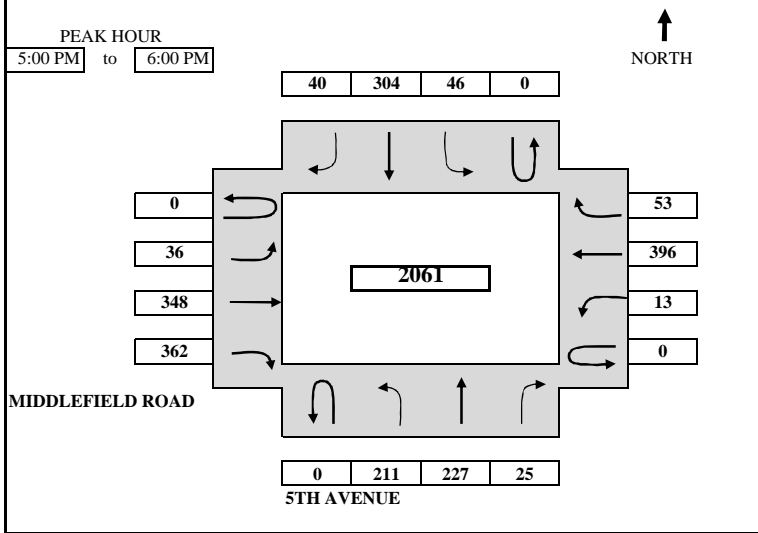

TIME PERIOD	NORTHBOUND				SOUTHBOUND				EASTBOUND				WESTBOUND				TOTAL
	U-TURN	LEFT	THRU	RIGHT	U-TURN	LEFT	THRU	RIGHT	U-TURN	LEFT	THRU	RIGHT	U-TURN	LEFT	THRU	RIGHT	

SURVEY DATA																
4:00 PM to 4:15 PM	43	64	3	12	59	11	14	88	62	5	86	10	457			
4:15 PM to 4:30 PM	102	131	13	27	110	24	20	178	136	10	151	29	931			
4:30 PM to 4:45 PM	156	202	15	34	174	32	30	254	222	12	245	48	1424			
4:45 PM to 5:00 PM	202	258	19	46	251	39	44	338	283	17	351	59	1907			
5:00 PM to 5:15 PM	248	309	26	53	334	47	55	441	385	18	458	73	2447			
5:15 PM to 5:30 PM	306	367	31	66	408	54	62	514	468	21	569	93	2959			
5:30 PM to 5:45 PM	361	419	36	81	488	65	68	616	559	26	651	97	3467			
5:45 PM to 6:00 PM	413	485	44	92	555	79	80	686	645	30	747	112	3968			

TOTAL BY PERIOD																	
4:00 PM to 4:15 PM	0	43	64	3	0	12	59	11	0	14	88	62	0	5	86	10	457
4:15 PM to 4:30 PM	0	59	67	10	0	15	51	13	0	6	90	74	0	5	65	19	474
4:30 PM to 4:45 PM	0	54	71	2	0	7	64	8	0	10	76	86	0	2	94	19	493
4:45 PM to 5:00 PM	0	46	56	4	0	12	77	7	0	14	84	61	0	5	106	11	483
5:00 PM to 5:15 PM	0	46	51	7	0	7	83	8	0	11	103	102	0	1	107	14	540
5:15 PM to 5:30 PM	0	58	58	5	0	13	74	7	0	7	73	83	0	3	111	20	512
5:30 PM to 5:45 PM	0	55	52	5	0	15	80	11	0	6	102	91	0	5	82	4	508
5:45 PM to 6:00 PM	0	52	66	8	0	11	67	14	0	12	70	86	0	4	96	15	501

HOURLY TOTALS																	
4:00 PM to 5:00 PM	0	202	258	19	0	46	251	39	0	44	338	283	0	17	351	59	1907
4:15 PM to 5:15 PM	0	205	245	23	0	41	275	36	0	41	353	323	0	13	372	63	1990
4:30 PM to 5:30 PM	0	204	236	18	0	39	298	30	0	42	336	332	0	11	418	64	2028
4:45 PM to 5:45 PM	0	205	217	21	0	47	314	33	0	38	362	337	0	14	406	49	2043
5:00 PM to 6:00 PM	0	211	227	25	0	46	304	40	0	36	348	362	0	13	396	53	2061

PEAK HOUR SUMMARY																	
5:00 PM to 6:00 PM	NORTHBOUND				SOUTHBOUND				EASTBOUND				WESTBOUND				TOTAL
	NBU	NBL	NBT	NBR	SBU	SBL	SBT	SBR	EBU	EBL	EBT	EBR	WBU	WBL	WBT	WBR	
VOLUME	0	211	227	25	0	46	304	40	0	36	348	362	0	13	396	53	2061
PEDESTRIAN																	168
BICYCLE																	17
PHF BY MOVEMENT	0.00	0.91	0.86	0.78	0.00	0.77	0.92	0.71	0.00	0.75	0.84	0.89	0.00	0.65	0.89	0.66	OVERALL
PHF BY APPROACH	0.92				0.92				0.86				0.86				0.95

TEL: (510) 232 - 1271 FAX: (510) 232 - 1272

B.A.Y.M.E.T.R.I.C.S.

BICYCLE MOVEMENT SUMMARY

PROJECT: TRAFFIC COUNTS IN SAN MATEO COUNTY	SURVEY DATE: 4/24/2014	DAY: THURSDAY
N-S APPROACH: 5TH AVENUE	SURVEY TIME: 4:00 PM	TO 6:00 PM
E-W APPROACH: MIDDLEFIELD ROAD	JURISDICTION: N. FAIR OAKS	FILE: 3404048-1PM

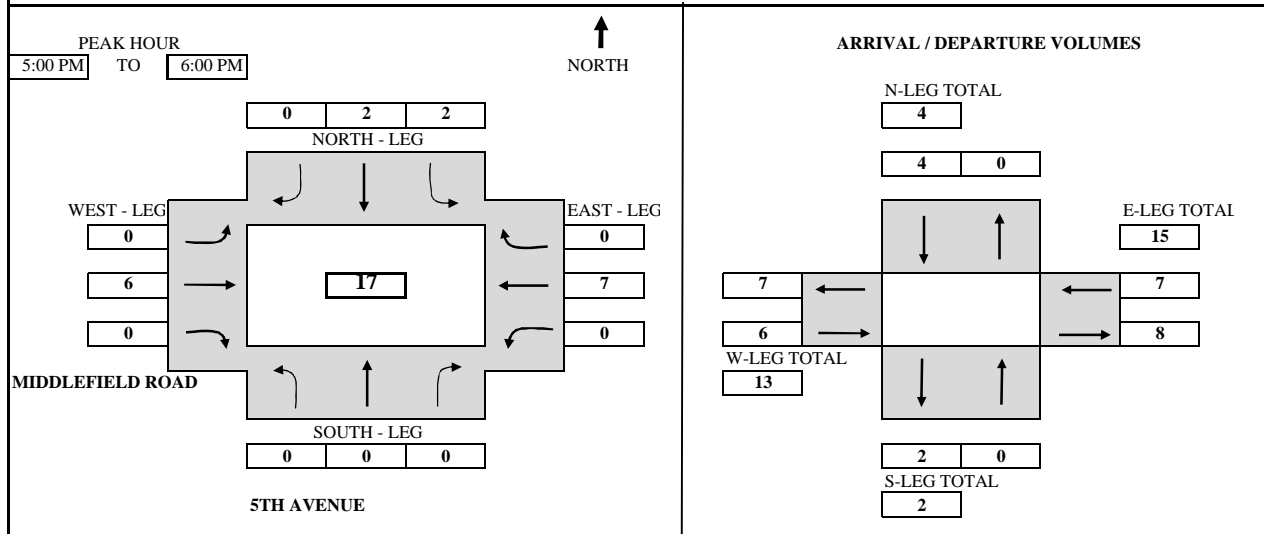

TIME	PERIOD	NB (SOUTH - LEG)			SB (NORTH - LEG)			EB (WEST - LEG)			WB (EAST - LEG)			TOTAL
		LEFT	THRU	RIGHT	LEFT	THRU	RIGHT	LEFT	THRU	RIGHT	LEFT	THRU	RIGHT	

SURVEY DATA															
4:00 PM	to	4:15 PM	0	0	0	0	2	0	0	3	0	0	0	0	5
4:15 PM	to	4:30 PM	0	0	0	0	2	0	0	3	0	0	0	1	6
4:30 PM	to	4:45 PM	0	1	0	0	2	0	0	5	0	0	1	1	10
4:45 PM	to	5:00 PM	0	2	0	0	2	0	0	5	0	0	1	1	11
5:00 PM	to	5:15 PM	0	2	0	0	3	0	0	5	0	0	2	1	13
5:15 PM	to	5:30 PM	0	2	0	0	4	0	0	8	0	0	5	1	20
5:30 PM	to	5:45 PM	0	2	0	2	4	0	0	9	0	0	7	1	25
5:45 PM	to	6:00 PM	0	2	0	2	4	0	0	11	0	0	8	1	28

TOTAL BY PERIOD															
4:00 PM	to	4:15 PM	0	0	0	0	2	0	0	3	0	0	0	0	5
4:15 PM	to	4:30 PM	0	0	0	0	0	0	0	0	0	0	0	1	1
4:30 PM	to	4:45 PM	0	1	0	0	0	0	0	2	0	0	1	0	4
4:45 PM	to	5:00 PM	0	1	0	0	0	0	0	0	0	0	0	0	1
5:00 PM	to	5:15 PM	0	0	0	0	1	0	0	0	0	0	1	0	2
5:15 PM	to	5:30 PM	0	0	0	0	1	0	0	3	0	0	3	0	7
5:30 PM	to	5:45 PM	0	0	0	2	0	0	0	1	0	0	2	0	5
5:45 PM	to	6:00 PM	0	0	0	0	0	0	0	2	0	0	1	0	3

HOURLY TOTALS															
4:00 PM	to	5:00 PM	0	2	0	0	2	0	0	5	0	0	1	1	11
4:15 PM	to	5:15 PM	0	2	0	0	1	0	0	2	0	0	2	1	8
4:30 PM	to	5:30 PM	0	2	0	0	2	0	0	5	0	0	5	0	14
4:45 PM	to	5:45 PM	0	1	0	2	2	0	0	4	0	0	6	0	15
5:00 PM	to	6:00 PM	0	0	0	2	2	0	0	6	0	0	7	0	17

TEL: (510) 232 - 1271 FAX: (510) 232 - 1272

5:00 PM	to	6:00 PM					
VOLUME BY APPROACH			NBT	SBT	EBT	WBT	TOTAL
BICYCLE			0	4	6	7	17

B.A.Y.M.E.T.R.I.C.S.

PEDESTRIAN MOVEMENT SUMMARY

PROJECT: TRAFFIC COUNTS IN SAN MATEO COUNTY		SURVEY DATE: 4/24/2014	
N-S APPROACH: 5TH AVENUE		DAY: THURSDAY	
E-W APPROACH: MIDDLEFIELD ROAD		JURISDICTION: N. FAIR OAKS	
SURVEY PERIOD 4:00 PM TO 6:00 PM		FILE: 3404048-1PM	

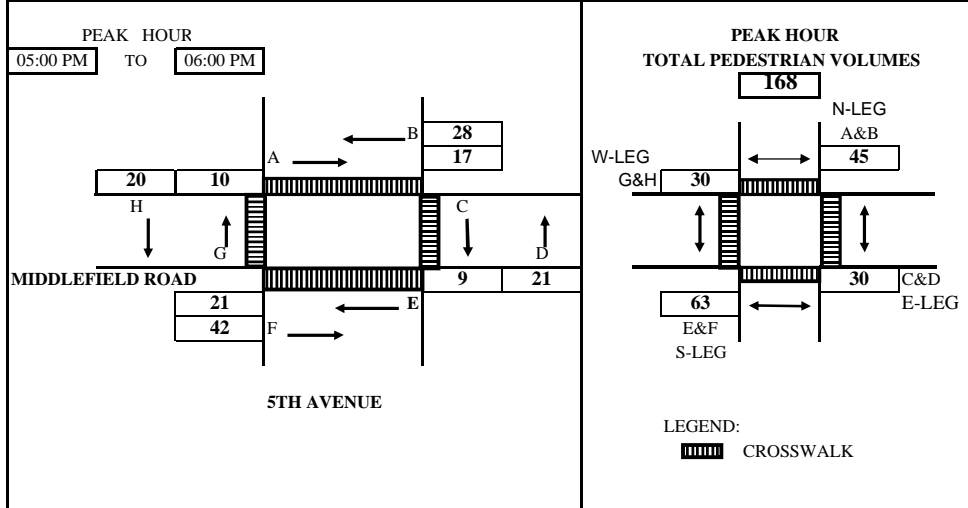

TIME PERIOD		NORTH X-WALK		EAST X-WALK		SOUTH X-WALK		WEST X-WALK		TOTAL	
From	To	A	B	C	D	E	F	G	H		
SURVEY DATA											
04:00 PM	---	04:15 PM	2	16	1	0	4	7	7	8	45
04:15 PM	---	04:30 PM	13	24	3	3	10	13	14	16	96
04:30 PM	---	04:45 PM	23	34	6	10	29	16	16	22	156
04:45 PM	---	05:00 PM	29	46	9	14	39	24	16	32	209
05:00 PM	---	05:15 PM	29	55	10	17	44	40	19	34	248
05:15 PM	---	05:30 PM	34	61	14	21	47	50	22	40	289
05:30 PM	---	05:45 PM	45	68	14	32	57	53	24	47	340
05:45 PM	---	06:00 PM	46	74	18	35	60	66	26	52	377
TOTAL BY PERIOD											
04:00 PM	---	04:15 PM	2	16	1	0	4	7	7	8	45
04:15 PM	---	04:30 PM	11	8	2	3	6	6	7	8	51
04:30 PM	---	04:45 PM	10	10	3	7	19	3	2	6	60
04:45 PM	---	05:00 PM	6	12	3	4	10	8	0	10	53
05:00 PM	---	05:15 PM	0	9	1	3	5	16	3	2	39
05:15 PM	---	05:30 PM	5	6	4	4	3	10	3	6	41
05:30 PM	---	05:45 PM	11	7	0	11	10	3	2	7	51
05:45 PM	---	06:00 PM	1	6	4	3	3	13	2	5	37
HOURLY TOTALS											
04:00 PM	---	05:00 PM	29	46	9	14	39	24	16	32	209
04:15 PM	---	05:15 PM	27	39	9	17	40	33	12	26	203
04:30 PM	---	05:30 PM	21	37	11	18	37	37	8	24	193
04:45 PM	---	05:45 PM	22	34	8	22	28	37	8	25	184
05:00 PM	---	06:00 PM	17	28	9	21	21	42	10	20	168
Tel : (510) 232-1271			Fax: (510) 232-1272								

5:00 PM	to	6:00 PM					
VOLUME BY LEG			N-LEG	S-LEG	E-LEG	W-LEG	TOTAL
PEDESTRIAN			45	63	30	30	168

APPENDIX B: LOS Analysis Sheets (Existing Conditions)

HCM Signalized Intersection Capacity Analysis

1: Fifth Avenue & Waverly Avenue

AM Existing
4/29/2014



Movement	SEL	SER	NEL	NET	SWT	SWR
Lane Configurations						
Volume (vph)	24	24	6	792	1096	17
Ideal Flow (vphpl)	1900	1900	1900	1900	1900	1900
Total Lost time (s)	3.5			4.5	4.5	
Lane Util. Factor	1.00			0.95	0.95	
Frbp, ped/bikes	1.00			1.00	1.00	
Flpb, ped/bikes	1.00			1.00	1.00	
Frt	0.93			1.00	1.00	
Flt Protected	0.98			1.00	1.00	
Satd. Flow (prot)	1695			3538	3529	
Flt Permitted	0.98			0.95	1.00	
Satd. Flow (perm)	1695			3351	3529	
Peak-hour factor, PHF	0.71	0.71	0.88	0.88	0.92	0.92
Adj. Flow (vph)	34	34	7	900	1191	18
RTOR Reduction (vph)	31	0	0	0	1	0
Lane Group Flow (vph)	37	0	0	907	1208	0
Confl. Peds. (#/hr)	16		25			25
Confl. Bikes (#/hr)						5
Turn Type	Prot		Perm	NA	NA	
Protected Phases	4			2	6	
Permitted Phases			2			
Actuated Green, G (s)	4.9			35.5	35.5	
Effective Green, g (s)	4.9			35.5	35.5	
Actuated g/C Ratio	0.10			0.73	0.73	
Clearance Time (s)	3.5			4.5	4.5	
Vehicle Extension (s)	1.0			6.0	6.0	
Lane Grp Cap (vph)	171			2457	2588	
v/s Ratio Prot	c0.02				c0.34	
v/s Ratio Perm				0.27		
v/c Ratio	0.22			0.37	0.47	
Uniform Delay, d1	20.0			2.4	2.6	
Progression Factor	1.00			1.00	1.00	
Incremental Delay, d2	0.2			0.4	0.6	
Delay (s)	20.2			2.8	3.2	
Level of Service	C			A	A	
Approach Delay (s)	20.2			2.8	3.2	
Approach LOS	C			A	A	

Intersection Summary

HCM 2000 Control Delay	3.6	HCM 2000 Level of Service	A
HCM 2000 Volume to Capacity ratio	0.44		
Actuated Cycle Length (s)	48.4	Sum of lost time (s)	8.0
Intersection Capacity Utilization	44.6%	ICU Level of Service	A
Analysis Period (min)	15		
c Critical Lane Group			

HCM Signalized Intersection Capacity Analysis

2: El Camino Real & Fifth Avenue

AM Existing
4/29/2014



















Movement	SEL	SET	NWT	NWR	SWL	SWR
Lane Configurations						
Volume (vph)	701	1550	748	221	429	603
Ideal Flow (vphpl)	1900	1900	1900	1900	1900	1900
Total Lost time (s)	4.0	4.0	4.0		4.0	4.0
Lane Util. Factor	0.97	0.91	0.91		1.00	0.88
Frbp, ped/bikes	1.00	1.00	0.99		1.00	1.00
Flpb, ped/bikes	1.00	1.00	1.00		1.00	1.00
Frt	1.00	1.00	0.97		1.00	0.85
Flt Protected	0.95	1.00	1.00		0.95	1.00
Satd. Flow (prot)	3433	5085	4882		1770	2787
Flt Permitted	0.95	1.00	1.00		0.95	1.00
Satd. Flow (perm)	3433	5085	4882		1770	2787
Peak-hour factor, PHF	0.93	0.93	0.96	0.96	0.83	0.83
Adj. Flow (vph)	754	1667	779	230	517	727
RTOR Reduction (vph)	0	0	89	0	0	0
Lane Group Flow (vph)	754	1667	920	0	517	727
Confl. Peds. (#/hr)				10	10	
Confl. Bikes (#/hr)				4		
Turn Type	Prot	NA	NA		Prot	pt+ov
Protected Phases	1	6	2		8	8 1
Permitted Phases						
Actuated Green, G (s)	14.0	34.0	16.0		18.0	36.0
Effective Green, g (s)	14.0	34.0	16.0		18.0	36.0
Actuated g/C Ratio	0.23	0.57	0.27		0.30	0.60
Clearance Time (s)	4.0	4.0	4.0		4.0	
Vehicle Extension (s)	3.0	3.0	3.0		3.0	
Lane Grp Cap (vph)	801	2881	1301		531	1672
v/s Ratio Prot	c0.22	0.33	c0.19		c0.29	0.26
v/s Ratio Perm						
v/c Ratio	0.94	0.58	0.71		0.97	0.43
Uniform Delay, d1	22.6	8.4	19.9		20.8	6.5
Progression Factor	1.00	1.00	1.00		1.00	1.00
Incremental Delay, d2	19.0	0.9	3.3		32.1	0.2
Delay (s)	41.6	9.2	23.1		52.9	6.7
Level of Service	D	A	C		D	A
Approach Delay (s)		19.3	23.1		25.9	
Approach LOS		B	C		C	
Intersection Summary						
HCM 2000 Control Delay			21.9		HCM 2000 Level of Service	C
HCM 2000 Volume to Capacity ratio			0.88			
Actuated Cycle Length (s)			60.0		Sum of lost time (s)	12.0
Intersection Capacity Utilization			73.4%		ICU Level of Service	D
Analysis Period (min)			15			
c Critical Lane Group						

HCM Signalized Intersection Capacity Analysis

3: Fifth Avenue & Middlefield Road

AM Existing
4/29/2014

												
Movement	NBL	NBT	NBR	SBL	SBT	SBR	SEL	SET	SER	NWL	NWT	NWR
Lane Configurations												
Volume (vph)	160	223	27	79	344	31	25	426	357	9	250	56
Ideal Flow (vphpl)	1900	1900	1900	1900	1900	1900	1900	1900	1900	1900	1900	1900
Total Lost time (s)		4.0			4.0			4.0			4.0	
Lane Util. Factor		1.00			1.00			0.95			0.95	
Frbp, ped/bikes		1.00			1.00			0.96			0.99	
Flpb, ped/bikes		1.00			1.00			1.00			1.00	
Frt		0.99			0.99			0.93			0.97	
Flt Protected		0.98			0.99			1.00			1.00	
Satd. Flow (prot)		1807			1826			3155			3392	
Flt Permitted		0.98			0.99			0.93			0.85	
Satd. Flow (perm)		1807			1826			2940			2882	
Peak-hour factor, PHF	0.80	0.80	0.80	0.88	0.88	0.88	0.87	0.87	0.87	0.77	0.77	0.77
Adj. Flow (vph)	200	279	34	90	391	35	29	490	410	12	325	73
RTOR Reduction (vph)	0	3	0	0	3	0	0	151	0	0	19	0
Lane Group Flow (vph)	0	510	0	0	513	0	0	778	0	0	391	0
Confl. Peds. (#/hr)			16			18	20		50	50		20
Confl. Bikes (#/hr)			1			1			6			2
Turn Type	Split	NA		Split	NA		Perm	NA		Perm	NA	
Protected Phases	3	3		4	4			2			6	
Permitted Phases							2			6		
Actuated Green, G (s)		27.0			27.0			29.0			29.0	
Effective Green, g (s)		27.0			27.0			29.0			29.0	
Actuated g/C Ratio		0.28			0.28			0.31			0.31	
Clearance Time (s)		4.0			4.0			4.0			4.0	
Vehicle Extension (s)		3.0			3.0			3.0			3.0	
Lane Grp Cap (vph)		513			518			897			879	
v/s Ratio Prot		c0.28			c0.28							
v/s Ratio Perm								c0.26			0.14	
v/c Ratio		0.99			0.99			0.87			0.44	
Uniform Delay, d1		33.9			33.9			31.2			26.5	
Progression Factor		1.00			1.00			1.00			1.00	
Incremental Delay, d2		38.1			37.0			11.1			1.6	
Delay (s)		72.0			70.9			42.3			28.2	
Level of Service		E			E			D			C	
Approach Delay (s)		72.0			70.9			42.3			28.2	
Approach LOS		E			E			D			C	
Intersection Summary												
HCM 2000 Control Delay			52.5								HCM 2000 Level of Service	D
HCM 2000 Volume to Capacity ratio			0.95									
Actuated Cycle Length (s)			95.0							12.0		
Intersection Capacity Utilization			94.8%								ICU Level of Service	F
Analysis Period (min)			15									
c	Critical Lane Group											

HCM Signalized Intersection Capacity Analysis
1: Fifth Avenue & Waverly Avenue

PM Existing
5/2/2014



Movement	SEL	SER	NEL	NET	SWT	SWR
Lane Configurations						
Volume (vph)	26	16	12	853	895	18
Ideal Flow (vphpl)	1900	1900	1900	1900	1900	1900
Total Lost time (s)	3.5			4.5	4.5	
Lane Util. Factor	1.00			0.95	0.95	
Frbp, ped/bikes	1.00			1.00	1.00	
Flpb, ped/bikes	1.00			1.00	1.00	
Frt	0.95			1.00	1.00	
Flt Protected	0.97			1.00	1.00	
Satd. Flow (prot)	1714			3536	3525	
Flt Permitted	0.97			0.94	1.00	
Satd. Flow (perm)	1714			3328	3525	
Peak-hour factor, PHF	0.71	0.71	0.88	0.88	0.92	0.92
Adj. Flow (vph)	37	23	14	969	973	20
RTOR Reduction (vph)	21	0	0	0	1	0
Lane Group Flow (vph)	39	0	0	983	992	0
Confl. Peds. (#/hr)	16		25			25
Confl. Bikes (#/hr)						5
Turn Type	Prot		Perm	NA	NA	
Protected Phases	4			2	6	
Permitted Phases			2			
Actuated Green, G (s)	3.3			37.1	37.1	
Effective Green, g (s)	3.3			37.1	37.1	
Actuated g/C Ratio	0.07			0.77	0.77	
Clearance Time (s)	3.5			4.5	4.5	
Vehicle Extension (s)	1.0			6.0	6.0	
Lane Grp Cap (vph)	116			2551	2702	
v/s Ratio Prot	c0.02				0.28	
v/s Ratio Perm				c0.30		
v/c Ratio	0.33			0.39	0.37	
Uniform Delay, d1	21.5			1.9	1.8	
Progression Factor	1.00			1.00	1.00	
Incremental Delay, d2	0.6			0.4	0.4	
Delay (s)	22.1			2.3	2.2	
Level of Service	C			A	A	
Approach Delay (s)	22.1			2.3	2.2	
Approach LOS	C			A	A	

Intersection Summary			
HCM 2000 Control Delay	2.9	HCM 2000 Level of Service	A
HCM 2000 Volume to Capacity ratio	0.38		
Actuated Cycle Length (s)	48.4	Sum of lost time (s)	8.0
Intersection Capacity Utilization	45.8%	ICU Level of Service	A
Analysis Period (min)	15		
c Critical Lane Group			

HCM Signalized Intersection Capacity Analysis

2: El Camino Real & Fifth Avenue

PM Existing
5/2/2014



Movement	SEL	SET	NWT	NWR	SWL	SWR
Lane Configurations	↔↔	↑↑↑	↑↑↑		↔	↔↔
Volume (vph)	544	971	1554	268	253	741
Ideal Flow (vphpl)	1900	1900	1900	1900	1900	1900
Total Lost time (s)	4.0	4.0	4.0		4.0	4.0
Lane Util. Factor	0.97	0.91	0.91		1.00	0.88
Frbp, ped/bikes	1.00	1.00	1.00		1.00	1.00
Flpb, ped/bikes	1.00	1.00	1.00		1.00	1.00
Frt	1.00	1.00	0.98		1.00	0.85
Flt Protected	0.95	1.00	1.00		0.95	1.00
Satd. Flow (prot)	3433	5085	4953		1770	2787
Flt Permitted	0.95	1.00	1.00		0.95	1.00
Satd. Flow (perm)	3433	5085	4953		1770	2787
Peak-hour factor, PHF	0.93	0.93	0.96	0.96	0.83	0.83
Adj. Flow (vph)	585	1044	1619	279	305	893
RTOR Reduction (vph)	0	0	35	0	0	0
Lane Group Flow (vph)	585	1044	1863	0	305	893
Confl. Peds. (#/hr)				10	10	
Confl. Bikes (#/hr)				4		
Turn Type	Prot	NA	NA		Prot	pt+ov
Protected Phases	1	6	2		8	8 1
Permitted Phases						
Actuated Green, G (s)	13.0	46.0	29.0		16.0	33.0
Effective Green, g (s)	13.0	46.0	29.0		16.0	33.0
Actuated g/C Ratio	0.19	0.66	0.41		0.23	0.47
Clearance Time (s)	4.0	4.0	4.0		4.0	
Vehicle Extension (s)	3.0	3.0	3.0		3.0	
Lane Grp Cap (vph)	637	3341	2051		404	1313
v/s Ratio Prot	c0.17	0.21	c0.38		c0.17	0.32
v/s Ratio Perm						
v/c Ratio	0.92	0.31	0.91		0.75	0.68
Uniform Delay, d1	28.0	5.2	19.3		25.2	14.4
Progression Factor	1.00	1.00	1.00		1.00	1.00
Incremental Delay, d2	18.2	0.2	7.4		7.8	1.5
Delay (s)	46.2	5.4	26.6		33.0	15.9
Level of Service	D	A	C		C	B
Approach Delay (s)		20.1	26.6		20.2	
Approach LOS		C	C		C	

















Intersection Summary

HCM 2000 Control Delay	22.7	HCM 2000 Level of Service	C
HCM 2000 Volume to Capacity ratio	0.87		
Actuated Cycle Length (s)	70.0	Sum of lost time (s)	12.0
Intersection Capacity Utilization	75.7%	ICU Level of Service	D
Analysis Period (min)	15		
c Critical Lane Group			

HCM Signalized Intersection Capacity Analysis

3: Fifth Avenue & Middlefield Road

PM Existing
5/2/2014

												
Movement	NBL	NBT	NBR	SBL	SBT	SBR	SEL	SET	SER	NWL	NWT	NWR
Lane Configurations												
Volume (vph)	211	227	25	46	304	40	36	348	362	13	396	53
Ideal Flow (vphpl)	1900	1900	1900	1900	1900	1900	1900	1900	1900	1900	1900	1900
Total Lost time (s)		4.0			4.0			4.0			4.0	
Lane Util. Factor		1.00			1.00			0.95			0.95	
Frbp, ped/bikes		1.00			1.00			0.95			0.99	
Flpb, ped/bikes		1.00			1.00			1.00			1.00	
Frt		0.99			0.99			0.93			0.98	
Flt Protected		0.98			0.99			1.00			1.00	
Satd. Flow (prot)		1805			1821			3118			3443	
Flt Permitted		0.98			0.99			0.87			0.87	
Satd. Flow (perm)		1805			1821			2705			2983	
Peak-hour factor, PHF	0.80	0.80	0.80	0.88	0.88	0.88	0.87	0.87	0.87	0.77	0.77	0.77
Adj. Flow (vph)	264	284	31	52	345	45	41	400	416	17	514	69
RTOR Reduction (vph)	0	2	0	0	4	0	0	178	0	0	10	0
Lane Group Flow (vph)	0	577	0	0	438	0	0	679	0	0	590	0
Confl. Peds. (#/hr)			16			18	20		50	50		20
Confl. Bikes (#/hr)			1			1			6			2
Turn Type	Split	NA		Split	NA		Perm	NA		Perm	NA	
Protected Phases	3	3		4	4			2			6	
Permitted Phases							2			6		
Actuated Green, G (s)		27.0			25.0			29.0			29.0	
Effective Green, g (s)		27.0			25.0			29.0			29.0	
Actuated g/C Ratio		0.29			0.27			0.31			0.31	
Clearance Time (s)		4.0			4.0			4.0			4.0	
Vehicle Extension (s)		3.0			3.0			3.0			3.0	
Lane Grp Cap (vph)		524			489			843			930	
v/s Ratio Prot		c0.32			c0.24							
v/s Ratio Perm								c0.25			0.20	
v/c Ratio		1.10			0.89			0.81			0.63	
Uniform Delay, d1		33.0			32.7			29.4			27.4	
Progression Factor		1.00			1.00			1.00			1.00	
Incremental Delay, d2		69.8			18.6			8.1			3.3	
Delay (s)		102.8			51.3			37.5			30.7	
Level of Service		F			D			D			C	
Approach Delay (s)		102.8			51.3			37.5			30.7	
Approach LOS		F			D			D			C	
Intersection Summary												
HCM 2000 Control Delay			53.6								HCM 2000 Level of Service	D
HCM 2000 Volume to Capacity ratio			0.93									
Actuated Cycle Length (s)			93.0							12.0		
Intersection Capacity Utilization			108.7%								ICU Level of Service	G
Analysis Period (min)			15									
c	Critical Lane Group											

APPENDIX C: LOS Analysis Sheets (Existing plus Project Conditions)

HCM Signalized Intersection Capacity Analysis
 1: Fifth Avenue & Waverly Avenue

AM Existing + Project
 7/21/2014



Movement	SEL	SER	NEL	NET	SWT	SWR
Lane Configurations						
Volume (vph)	24	24	6	793	1104	17
Ideal Flow (vphpl)	1900	1900	1900	1900	1900	1900
Total Lost time (s)	3.5			4.5	4.5	
Lane Util. Factor	1.00			0.95	0.95	
Frbp, ped/bikes	1.00			1.00	1.00	
Flpb, ped/bikes	1.00			1.00	1.00	
Frt	0.93			1.00	1.00	
Flt Protected	0.98			1.00	1.00	
Satd. Flow (prot)	1695			3538	3529	
Flt Permitted	0.98			0.95	1.00	
Satd. Flow (perm)	1695			3351	3529	
Peak-hour factor, PHF	0.71	0.71	0.88	0.88	0.92	0.92
Adj. Flow (vph)	34	34	7	901	1200	18
RTOR Reduction (vph)	30	0	0	0	1	0
Lane Group Flow (vph)	38	0	0	908	1217	0
Confl. Peds. (#/hr)	16		25			25
Confl. Bikes (#/hr)						5
Turn Type	Prot		Perm	NA	NA	
Protected Phases	4			2	6	
Permitted Phases			2			
Actuated Green, G (s)	4.9			35.5	35.5	
Effective Green, g (s)	4.9			35.5	35.5	
Actuated g/C Ratio	0.10			0.73	0.73	
Clearance Time (s)	3.5			4.5	4.5	
Vehicle Extension (s)	1.0			6.0	6.0	
Lane Grp Cap (vph)	171			2457	2588	
v/s Ratio Prot	c0.02				c0.34	
v/s Ratio Perm				0.27		
v/c Ratio	0.22			0.37	0.47	
Uniform Delay, d1	20.0			2.4	2.6	
Progression Factor	1.00			1.00	1.00	
Incremental Delay, d2	0.2			0.4	0.6	
Delay (s)	20.2			2.8	3.2	
Level of Service	C			A	A	
Approach Delay (s)	20.2			2.8	3.2	
Approach LOS	C			A	A	

Intersection Summary

HCM 2000 Control Delay	3.6	HCM 2000 Level of Service	A
HCM 2000 Volume to Capacity ratio	0.44		
Actuated Cycle Length (s)	48.4	Sum of lost time (s)	8.0
Intersection Capacity Utilization	44.8%	ICU Level of Service	A
Analysis Period (min)	15		
c Critical Lane Group			

HCM Signalized Intersection Capacity Analysis

2: El Camino Real & Fifth Avenue

AM Existing + Project
7/21/2014



















Movement	SEL	SET	NWT	NWR	SWL	SWR
Lane Configurations	↔↔	↑↑↑	↑↑↑		↔	↔↔
Volume (vph)	702	1550	748	221	431	609
Ideal Flow (vphpl)	1900	1900	1900	1900	1900	1900
Total Lost time (s)	4.0	4.0	4.0		4.0	4.0
Lane Util. Factor	0.97	0.91	0.91		1.00	0.88
Frpb, ped/bikes	1.00	1.00	0.99		1.00	1.00
Flpb, ped/bikes	1.00	1.00	1.00		1.00	1.00
Frt	1.00	1.00	0.97		1.00	0.85
Flt Protected	0.95	1.00	1.00		0.95	1.00
Satd. Flow (prot)	3433	5085	4882		1770	2787
Flt Permitted	0.95	1.00	1.00		0.95	1.00
Satd. Flow (perm)	3433	5085	4882		1770	2787
Peak-hour factor, PHF	0.93	0.93	0.96	0.96	0.83	0.83
Adj. Flow (vph)	755	1667	779	230	519	734
RTOR Reduction (vph)	0	0	89	0	0	0
Lane Group Flow (vph)	755	1667	920	0	519	734
Confl. Peds. (#/hr)				10	10	
Confl. Bikes (#/hr)				4		
Turn Type	Prot	NA	NA		Prot	pt+ov
Protected Phases	1	6	2		8	8 1
Permitted Phases						
Actuated Green, G (s)	14.0	34.0	16.0		18.0	36.0
Effective Green, g (s)	14.0	34.0	16.0		18.0	36.0
Actuated g/C Ratio	0.23	0.57	0.27		0.30	0.60
Clearance Time (s)	4.0	4.0	4.0		4.0	
Vehicle Extension (s)	3.0	3.0	3.0		3.0	
Lane Grp Cap (vph)	801	2881	1301		531	1672
v/s Ratio Prot	c0.22	0.33	c0.19		c0.29	0.26
v/s Ratio Perm						
v/c Ratio	0.94	0.58	0.71		0.98	0.44
Uniform Delay, d1	22.6	8.4	19.9		20.8	6.5
Progression Factor	1.00	1.00	1.00		1.00	1.00
Incremental Delay, d2	19.2	0.9	3.3		32.9	0.2
Delay (s)	41.8	9.2	23.1		53.7	6.7
Level of Service	D	A	C		D	A
Approach Delay (s)		19.4	23.1		26.2	
Approach LOS		B	C		C	
Intersection Summary						
HCM 2000 Control Delay			22.0		HCM 2000 Level of Service	C
HCM 2000 Volume to Capacity ratio			0.88			
Actuated Cycle Length (s)			60.0		Sum of lost time (s)	12.0
Intersection Capacity Utilization			73.5%		ICU Level of Service	D
Analysis Period (min)			15			
c Critical Lane Group						

HCM Signalized Intersection Capacity Analysis

3: Fifth Avenue & Middlefield Road

AM Existing + Project

7/21/2014



















												
Movement	NBL	NBT	NBR	SBL	SBT	SBR	SEL	SET	SER	NWL	NWT	NWR
Lane Configurations												
Volume (vph)	164	227	27	79	345	31	25	426	357	9	250	56
Ideal Flow (vphpl)	1900	1900	1900	1900	1900	1900	1900	1900	1900	1900	1900	1900
Total Lost time (s)		4.0			4.0			4.0			4.0	
Lane Util. Factor		1.00			1.00			0.95			0.95	
Frbp, ped/bikes		1.00			1.00			0.96			0.99	
Flpb, ped/bikes		1.00			1.00			1.00			1.00	
Frt		0.99			0.99			0.93			0.97	
Flt Protected		0.98			0.99			1.00			1.00	
Satd. Flow (prot)		1807			1826			3155			3392	
Flt Permitted		0.98			0.99			0.93			0.85	
Satd. Flow (perm)		1807			1826			2940			2882	
Peak-hour factor, PHF	0.80	0.80	0.80	0.88	0.88	0.88	0.87	0.87	0.87	0.77	0.77	0.77
Adj. Flow (vph)	205	284	34	90	392	35	29	490	410	12	325	73
RTOR Reduction (vph)	0	3	0	0	3	0	0	151	0	0	19	0
Lane Group Flow (vph)	0	520	0	0	514	0	0	778	0	0	391	0
Confl. Peds. (#/hr)			16			18	20		50	50		20
Confl. Bikes (#/hr)			1			1			6			2
Turn Type	Split	NA		Split	NA		Perm	NA		Perm	NA	
Protected Phases	3	3		4	4			2			6	
Permitted Phases							2			6		
Actuated Green, G (s)		27.0			27.0			29.0			29.0	
Effective Green, g (s)		27.0			27.0			29.0			29.0	
Actuated g/C Ratio		0.28			0.28			0.31			0.31	
Clearance Time (s)		4.0			4.0			4.0			4.0	
Vehicle Extension (s)		3.0			3.0			3.0			3.0	
Lane Grp Cap (vph)		513			518			897			879	
v/s Ratio Prot		c0.29			c0.28							
v/s Ratio Perm								c0.26			0.14	
v/c Ratio		1.01			0.99			0.87			0.44	
Uniform Delay, d1		34.0			33.9			31.2			26.5	
Progression Factor		1.00			1.00			1.00			1.00	
Incremental Delay, d2		43.3			37.4			11.1			1.6	
Delay (s)		77.3			71.3			42.3			28.2	
Level of Service		E			E			D			C	
Approach Delay (s)		77.3			71.3			42.3			28.2	
Approach LOS		E			E			D			C	
Intersection Summary												
HCM 2000 Control Delay			53.8								HCM 2000 Level of Service	D
HCM 2000 Volume to Capacity ratio			0.95									
Actuated Cycle Length (s)			95.0							12.0		
Intersection Capacity Utilization			95.9%								ICU Level of Service	F
Analysis Period (min)			15									
c Critical Lane Group												

HCM Signalized Intersection Capacity Analysis

3: Fifth Avenue & Middlefield Road

AM Existing + Project - Mitigated

7/22/2014

														
Movement	NBL	NBT	NBR	SBL	SBT	SBR	SEL	SET	SER	NWL	NWT	NWR		
Lane Configurations														
Volume (vph)	164	227	27	79	345	31	25	426	357	9	250	56		
Ideal Flow (vphpl)	1900	1900	1900	1900	1900	1900	1900	1900	1900	1900	1900	1900		
Total Lost time (s)		4.0	4.0		4.0			4.0			4.0			
Lane Util. Factor		1.00	1.00		1.00			0.95			0.95			
Frbp, ped/bikes		1.00	0.97		1.00			0.96			0.99			
Flpb, ped/bikes		1.00	1.00		1.00			1.00			1.00			
Frt		1.00	0.85		0.99			0.93			0.97			
Flt Protected		0.98	1.00		0.99			1.00			1.00			
Satd. Flow (prot)		1825	1537		1826			3155			3393			
Flt Permitted		0.98	1.00		0.99			0.93			0.85			
Satd. Flow (perm)		1825	1537		1826			2941			2891			
Peak-hour factor, PHF	0.80	0.80	0.80	0.88	0.88	0.88	0.87	0.87	0.87	0.77	0.77	0.77		
Adj. Flow (vph)	205	284	34	90	392	35	29	490	410	12	325	73		
RTOR Reduction (vph)	0	0	24	0	3	0	0	150	0	0	19	0		
Lane Group Flow (vph)	0	489	10	0	514	0	0	779	0	0	391	0		
Confl. Peds. (#/hr)			16			18	20		50	50		20		
Confl. Bikes (#/hr)			1			1			6			2		
Turn Type	Split	NA	Perm	Split	NA		Perm	NA		Perm	NA			
Protected Phases	3	3		4	4			2				6		
Permitted Phases			3				2			6				
Actuated Green, G (s)		26.6	26.6		27.0			29.0			29.0			
Effective Green, g (s)		26.6	26.6		27.0			29.0			29.0			
Actuated g/C Ratio		0.28	0.28		0.29			0.31			0.31			
Clearance Time (s)		4.0	4.0		4.0			4.0			4.0			
Vehicle Extension (s)		3.0	3.0		3.0			3.0			3.0			
Lane Grp Cap (vph)		513	432		521			901			886			
v/s Ratio Prot		c0.27			c0.28									
v/s Ratio Perm			0.01					c0.26			0.14			
v/c Ratio		0.95	0.02		0.99			0.86			0.44			
Uniform Delay, d1		33.4	24.6		33.6			30.9			26.3			
Progression Factor		1.00	1.00		1.00			1.00			1.00			
Incremental Delay, d2		28.1	0.0		35.7			10.8			1.6			
Delay (s)		61.5	24.6		69.3			41.7			27.9			
Level of Service		E	C		E			D			C			
Approach Delay (s)		59.1			69.3			41.7			27.9			
Approach LOS		E			E			D			C			
Intersection Summary														
HCM 2000 Control Delay			49.2									HCM 2000 Level of Service	D	
HCM 2000 Volume to Capacity ratio			0.93											
Actuated Cycle Length (s)			94.6								12.0			
Intersection Capacity Utilization			100.5%										ICU Level of Service	G
Analysis Period (min)			15											
c	Critical Lane Group													

HCM Signalized Intersection Capacity Analysis
 1: Fifth Avenue & Waverly Avenue

PM Existing + Project
 7/21/2014

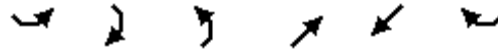

Movement	SEL	SER	NEL	NET	SWT	SWR
Lane Configurations						
Volume (vph)	26	16	12	861	896	18
Ideal Flow (vphpl)	1900	1900	1900	1900	1900	1900
Total Lost time (s)	3.5			4.5	4.5	
Lane Util. Factor	1.00			0.95	0.95	
Frbp, ped/bikes	1.00			1.00	1.00	
Flpb, ped/bikes	1.00			1.00	1.00	
Frt	0.95			1.00	1.00	
Flt Protected	0.97			1.00	1.00	
Satd. Flow (prot)	1714			3536	3525	
Flt Permitted	0.97			0.94	1.00	
Satd. Flow (perm)	1714			3328	3525	
Peak-hour factor, PHF	0.71	0.71	0.88	0.88	0.92	0.92
Adj. Flow (vph)	37	23	14	978	974	20
RTOR Reduction (vph)	21	0	0	0	1	0
Lane Group Flow (vph)	39	0	0	992	993	0
Confl. Peds. (#/hr)	16		25			25
Confl. Bikes (#/hr)						5
Turn Type	Prot		Perm	NA	NA	
Protected Phases	4			2	6	
Permitted Phases			2			
Actuated Green, G (s)	3.3			37.1	37.1	
Effective Green, g (s)	3.3			37.1	37.1	
Actuated g/C Ratio	0.07			0.77	0.77	
Clearance Time (s)	3.5			4.5	4.5	
Vehicle Extension (s)	1.0			6.0	6.0	
Lane Grp Cap (vph)	116			2551	2702	
v/s Ratio Prot	c0.02				0.28	
v/s Ratio Perm				c0.30		
v/c Ratio	0.33			0.39	0.37	
Uniform Delay, d1	21.5			1.9	1.8	
Progression Factor	1.00			1.00	1.00	
Incremental Delay, d2	0.6			0.4	0.4	
Delay (s)	22.1			2.3	2.2	
Level of Service	C			A	A	
Approach Delay (s)	22.1			2.3	2.2	
Approach LOS	C			A	A	

Intersection Summary

HCM 2000 Control Delay	2.9	HCM 2000 Level of Service	A
HCM 2000 Volume to Capacity ratio	0.38		
Actuated Cycle Length (s)	48.4	Sum of lost time (s)	8.0
Intersection Capacity Utilization	46.0%	ICU Level of Service	A
Analysis Period (min)	15		
c Critical Lane Group			

HCM Signalized Intersection Capacity Analysis
2: El Camino Real & Fifth Avenue

PM Existing + Project
7/21/2014



Movement	SEL	SET	NWT	NWR	SWL	SWR
Lane Configurations	↔↔	↑↑↑	↑↑↑		↔	↔↔
Volume (vph)	550	971	1554	270	253	742
Ideal Flow (vphpl)	1900	1900	1900	1900	1900	1900
Total Lost time (s)	4.0	4.0	4.0		4.0	4.0
Lane Util. Factor	0.97	0.91	0.91		1.00	0.88
Frbp, ped/bikes	1.00	1.00	1.00		1.00	1.00
Flpb, ped/bikes	1.00	1.00	1.00		1.00	1.00
Frt	1.00	1.00	0.98		1.00	0.85
Flt Protected	0.95	1.00	1.00		0.95	1.00
Satd. Flow (prot)	3433	5085	4953		1770	2787
Flt Permitted	0.95	1.00	1.00		0.95	1.00
Satd. Flow (perm)	3433	5085	4953		1770	2787
Peak-hour factor, PHF	0.93	0.93	0.96	0.96	0.83	0.83
Adj. Flow (vph)	591	1044	1619	281	305	894
RTOR Reduction (vph)	0	0	35	0	0	0
Lane Group Flow (vph)	591	1044	1865	0	305	894
Confl. Peds. (#/hr)				10	10	
Confl. Bikes (#/hr)				4		
Turn Type	Prot	NA	NA		Prot	pt+ov
Protected Phases	1	6	2		8	8 1
Permitted Phases						
Actuated Green, G (s)	13.0	46.0	29.0		16.0	33.0
Effective Green, g (s)	13.0	46.0	29.0		16.0	33.0
Actuated g/C Ratio	0.19	0.66	0.41		0.23	0.47
Clearance Time (s)	4.0	4.0	4.0		4.0	
Vehicle Extension (s)	3.0	3.0	3.0		3.0	
Lane Grp Cap (vph)	637	3341	2051		404	1313
v/s Ratio Prot	c0.17	0.21	c0.38		c0.17	0.32
v/s Ratio Perm						
v/c Ratio	0.93	0.31	0.91		0.75	0.68
Uniform Delay, d1	28.0	5.2	19.3		25.2	14.4
Progression Factor	1.00	1.00	1.00		1.00	1.00
Incremental Delay, d2	19.7	0.2	7.5		7.8	1.5
Delay (s)	47.7	5.4	26.7		33.0	15.9
Level of Service	D	A	C		C	B
Approach Delay (s)		20.7	26.7		20.2	
Approach LOS		C	C		C	

Intersection Summary

















HCM 2000 Control Delay	23.0	HCM 2000 Level of Service	C
HCM 2000 Volume to Capacity ratio	0.87		
Actuated Cycle Length (s)	70.0	Sum of lost time (s)	12.0
Intersection Capacity Utilization	75.9%	ICU Level of Service	D
Analysis Period (min)	15		
c Critical Lane Group			

HCM Signalized Intersection Capacity Analysis

3: Fifth Avenue & Middlefield Road

PM Existing + Project

7/21/2014

												
Movement	NBL	NBT	NBR	SBL	SBT	SBR	SEL	SET	SER	NWL	NWT	NWR
Lane Configurations												
Volume (vph)	211	228	25	46	308	40	36	348	366	13	396	53
Ideal Flow (vphpl)	1900	1900	1900	1900	1900	1900	1900	1900	1900	1900	1900	1900
Total Lost time (s)		4.0			4.0			4.0			4.0	
Lane Util. Factor		1.00			1.00			0.95			0.95	
Frbp, ped/bikes		1.00			1.00			0.95			0.99	
Flpb, ped/bikes		1.00			1.00			1.00			1.00	
Frt		0.99			0.99			0.93			0.98	
Flt Protected		0.98			0.99			1.00			1.00	
Satd. Flow (prot)		1805			1821			3116			3443	
Flt Permitted		0.98			0.99			0.86			0.86	
Satd. Flow (perm)		1805			1821			2700			2969	
Peak-hour factor, PHF	0.80	0.80	0.80	0.88	0.88	0.88	0.87	0.87	0.87	0.77	0.77	0.77
Adj. Flow (vph)	264	285	31	52	350	45	41	400	421	17	514	69
RTOR Reduction (vph)	0	2	0	0	4	0	0	180	0	0	10	0
Lane Group Flow (vph)	0	578	0	0	443	0	0	682	0	0	590	0
Confl. Peds. (#/hr)			16			18	20		50	50		20
Confl. Bikes (#/hr)			1			1			6			2
Turn Type	Split	NA		Split	NA		Perm	NA		Perm	NA	
Protected Phases	3	3		4	4			2			6	
Permitted Phases							2			6		
Actuated Green, G (s)		27.0			25.2			29.0			29.0	
Effective Green, g (s)		27.0			25.2			29.0			29.0	
Actuated g/C Ratio		0.29			0.27			0.31			0.31	
Clearance Time (s)		4.0			4.0			4.0			4.0	
Vehicle Extension (s)		3.0			3.0			3.0			3.0	
Lane Grp Cap (vph)		522			492			840			923	
v/s Ratio Prot		c0.32			c0.24							
v/s Ratio Perm								c0.25			0.20	
v/c Ratio		1.11			0.90			0.81			0.64	
Uniform Delay, d1		33.1			32.8			29.6			27.6	
Progression Factor		1.00			1.00			1.00			1.00	
Incremental Delay, d2		72.0			19.0			8.4			3.4	
Delay (s)		105.1			51.8			38.0			31.0	
Level of Service		F			D			D			C	
Approach Delay (s)		105.1			51.8			38.0			31.0	
Approach LOS		F			D			D			C	
Intersection Summary												
HCM 2000 Control Delay			54.4								HCM 2000 Level of Service	D
HCM 2000 Volume to Capacity ratio			0.94									
Actuated Cycle Length (s)			93.2						12.0			
Intersection Capacity Utilization			109.0%								ICU Level of Service	H
Analysis Period (min)			15									
c	Critical Lane Group											